

# K004

## Basic Manual

READ THIS MANUAL TO MASTER  
THE CELLULAR PHONE

[www.au.kddi.com](http://www.au.kddi.com)

Illustrations and  
Screenshots  
in This Manual

Notes on  
Cell Phone Use

Contents

Getting Ready

Making and  
Answering Calls

Character Input

Phone Book

Pair Function

Mail

Camera

EZweb

EZ News Flash

EZ Navi

In Case of  
Loss of Your K004

Troubleshooting

Index

# Introduction

Thank you for purchasing the K004. Before using your K004, be sure to read the K004 Basic Manual (this PDF manual) to ensure correct usage. After you have finished reading this manual, store this PDF manual and the printed manuals in safe places so you can retrieve them whenever you need them.

## Manuals for the K004

The K004 comes with the Basic Manual and Instruction Manual.

### ● For learning the basics:

Read the K004 Basic Manual (this manual).

### ● For learning details on using each function:

Read the supplied K004 Instruction Manual (Japanese). Be sure to read the Safety Precautions “安全上のご注意” to ensure proper usage of the K004.

The keyword searchable au Online Manual is also available on the au homepage:

<http://www.au.kddi.com/manual/index.html>

- To access from EZweb:  ⇒ *Top Menu/Search* ⇒ *auお客さまサポート* (au Customer Support) ⇒ *オンラインマニュアル* (Online Manual)



Scan this QR code to access the au Online Manual. ▶





The K004 default setting, or its setting after being reset, is "Simple Mode". To use K004 with the bilingual function, you must switch it "Normal Mode". Perform the following steps to switch to "Normal Mode". Descriptions in this manual are based on "Normal Mode".

When the standby screen is displayed, press .

➡ Use  /  to select *各種設定* (Set Functions) and then press  (選択 [select]).

➡ Use  /  to select *通常モード切替* (Switch to Normal mode) and then press  (選択 [select]).

➡ Use  /  to select *はい* (Yes) and then press  (OK).

After the K004 is set to "Normal Mode", refer to steps in page 10 to switch to English language mode.

# Illustrations and Screenshots in This Manual

## Note on Illustrations

The illustrations in this manual may look different from the actual cell phone in shape, color and typeface. The key illustrations are also simplified as shown below.

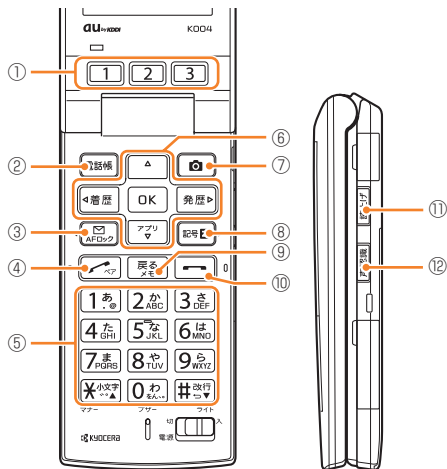

	Key Illustration		Key Illustration
①	1 2 3	⑥	▲ ◀ 着歴 OK 発歴 ▶ アプリ ▼
②	電話帳	⑦	📷
③	📧	⑧	📧
④	📞	⑨	戻る
⑤	1 2 3 4 5 6 7 8 9 * 0 #	⑩	☎
		⑪	読上げ
		⑫	声認識

## Note on Screenshots

The screenshots in this manual are simplified and may look different from the actual cell phone screens.

## Notes on Cell Phone Use

### Cell Phone Etiquette

The cell phone always emits weak radio waves when power is on.

Use the cell phone in an enjoyable and safe manner without forgetting to be considerate of others around you.

- **Use of cell phones is not allowed in some places.**
  - Do not use the cell phone while you are driving. Doing so is both dangerous and prohibited by law.
  - Using a cell phone in an aircraft is prohibited by law. Be sure to turn the cell phone power off.
- **Radio waves from cell phones may interfere with medical electrical equipment.**
  - Some people close to you in crowded places such as packed trains may be using a cardiac pacemaker. Turn the cell phone off in such places.
  - Abide by the rules of hospitals and other medical institutions where it is forbidden to use or carry cell phones.
- **Be considerate of where you use the cell phone and how loudly you talk.**
  - Do not make calls in theaters, museums, libraries, and other similar places. Turn power off or turn on manner mode not to disturb others around you by ring tones.
  - Do not use the cell phone on a street where you might interrupt the flow of pedestrians.
  - Move to areas where you will not inconvenience others on trains or in hotel lobbies.
  - Refrain from talking in a loud voice.

- Obtain the permission of other people before you take their photos with the cell phone's camera.
- Do not record information with the cell phone's camera in bookstores and other locations where taking photos is not permitted.

### Do Not Use the Cell Phone While Driving!

**Turn off your cell phone or put it in Drive Mode while driving.**

Do not use the cell phone while driving a car/motorcycle or riding a bicycle. It may result in a traffic accident. Using a cell phone while driving is prohibited by law. Using a cell phone while riding a bicycle may also be punishable by law.

#### Prohibited!

- Looking at a cell phone display
- Talking on a cell phone while holding it

#### Drive Mode

In Drive Mode, a Japanese message meaning "I'm driving now, so I can't answer your call." is played when a call is received, and asks the caller to leave a message on the answer memo.

- When the standby screen is displayed, press **[OK]**,
- ➡ Use **[△]** / **[アプリ]** / **[<履歴]** / **[履歴>]** to select *Tools* and then press **[OK]** (Select).
  - ➡ Use **[△]** / **[アプリ]** to select *Manner Mode* and then press **[OK]** (Select).
  - ➡ Use **[△]** / **[アプリ]** to select *Drive Mode* and then press **[OK]** (OK).

## Disaster Message Board Service

When a large scale disaster occurs, you can register your safety information from EZweb. The registered information can be referred from anywhere in Japan from EZweb or Internet.

### Registering safety information

- When a large scale disaster occurs, from an au phone, you can register your safety information (i.e. your condition and comments) to the 災害用伝言板 (Disaster Message Board) created on the EZweb.
- After registration of your safety information, e-mail is sent to your family or acquaintances you have previously designated to notify that your safety information has been uploaded to the 災害用伝言板 (Disaster Message Board).

### Inquiring for safety information

- You can inquire for safety information of a person by entering his/her phone number from EZweb or Internet.\*  
\* To inquire from other carriers' cell phone, a PHS or PC, access "<http://dengon.ezweb.ne.jp/>".

Access	 ⇒ Top Menu/Search ⇒ 災害用伝言板 (Disaster Message Board)
	<a href="http://dengon.ezweb.ne.jp/">http://dengon.ezweb.ne.jp/</a>

- The maximum storage period of the registered information is 72 hours.
- The maximum available number of registrations is 10 per phone number. When the number of registrations exceeds 10, the oldest one is overwritten.
- The demonstration of this service can be referred to anytime by pressing  ⇒ Top Menu/Search ⇒ auお客さまサポート (au Customer Support) ⇒ 調べる (Search) ⇒ 災害用伝言板 (デモ版) (Disaster Message Board (Demo Version)).
- To view the Disaster Message Board in English, select *English* from the top menu of the Disaster Message Board.

# Contents

## Introduction

### Illustrations and Screenshots in This Manual 1

### Notes on Cell Phone Use 2

Cell Phone Etiquette .....	2
Do Not Use the Cell Phone While Driving!.....	2
Disaster Message Board Service .....	3

### Contents 4

### Getting Ready 6

Checking the Contents of the Box .....	6
Names of Parts .....	7
Charging the Battery Pack .....	8
Learning the Basics .....	9
Turning On Power .....	10
Switching the Display Language to English .....	10
Initial Setup of E-mail and EZweb .....	11
Checking Your Phone Number and E-mail Address ...	11
Display Indicators .....	12
Using Main Menu .....	13
Changing Your E-mail Address.....	14
Security Code and Passwords.....	15

### Making and Answering Calls 16

Making a Call .....	16
Making an International Call.....	16
Answering a Call.....	17

Returning a Call (Outgoing History/Incoming History) ...	17
One-ring Calls.....	17
Adjusting the Earpiece Volume during a Call.....	18
Turning On Manner Mode.....	18
Changing the Incoming Ring Tone .....	18
Adjusting the Incoming Ring Tone Volume .....	19
Turning On the Answer Memo .....	19

### Character Input 21

Character Entry Modes .....	21
Entering Alphanumeric Characters .....	21
Entering E-mail Addresses .....	22
Entering Pictograms .....	23

### Phone Book 24

Saving a Phone Book Entry .....	24
Dialing from the Phone Book .....	24
Editing Phone Book Entries .....	24
Saving a Phone Number from the Incoming or Outgoing History .....	25

### Pair Function 26

Registering a Pair Partner.....	26
Making a Call to a Pair Partner .....	26
Sending Mail to a Pair Partner.....	26

### Mail 27

Using E-mail .....	27
Creating and Sending E-mail Messages .....	27
Reading Received E-mail Messages .....	28
Reading an E-mail Message with an Attached Photo or Movie .....	28

Replying to Received E-mail Messages .....	28	<b>In Case of Loss of Your K004</b>	<b>42</b>
Rejecting Spam .....	29	Setting Conditions for Activating the Remote Ctrl Lock...	42
Using C-mail .....	30	Remotely Activating the Remote Ctrl Lock	
Creating and Sending C-mail Messages .....	30	on Your K004 .....	43
Reading Received C-mail Messages .....	30	Activating the Remote Ctrl Lock	
<b>Camera</b>	<b>31</b>	by the Security Lock Service .....	43
Photo Taking Tips .....	31	<b>Troubleshooting</b>	<b>44</b>
About Photo Modes .....	31	<b>Index</b>	<b>46</b>
Taking a Photo .....	31		
Viewing Photos .....	32		
<b>EZweb</b>	<b>33</b>		
Accessing Sites .....	34		
Bookmarking Frequently Accessed Pages.....	35		
Viewing Bookmarked Pages.....	35		
Checking Charges .....	36		
Downloading Chaku-Uta®.....	36		
<b>EZ News Flash</b>	<b>37</b>		
Basic Operations .....	37		
Setting EZ News Flash .....	37		
<b>EZ Navi</b>	<b>39</b>		
Passenger Seat Navi for People			
in the Passenger Seat to Check the Route .....	39		
Security Navi to Check Where Your Kids Are.....	39		
EZ Navi Walk for When You Go Out .....	40		
Evacuate Navi to Guide You Home or to Nearby			
Evacuation Areas during Disasters .....	41		

# Getting Ready

## Checking the Contents of the Box

The box contains the cell phone and accessories.

- Cell phone
- Battery pack
- CD-ROM
- Instruction Manual (Japanese)
- Basic Manual (Japanese)
- Warranty (Japanese)
- Safety Precautions (Japanese)
- JIBUN BANK Launcher Operation Guide (Japanese)
- Global Passport mobile rental service Owner's Guide (Japanese)
- Easy Start Guide (Japanese)

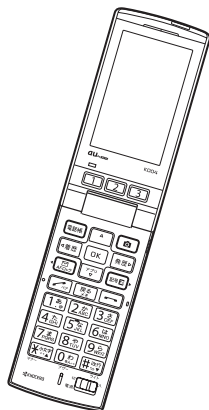

- Desktop holder

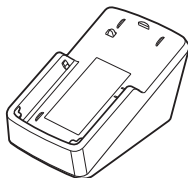

- An AC adapter and microSD memory card are not included. Purchase a specified AC adapter (sold separately) and a commercially available microSD memory card.



# Names of Parts

## From the Front

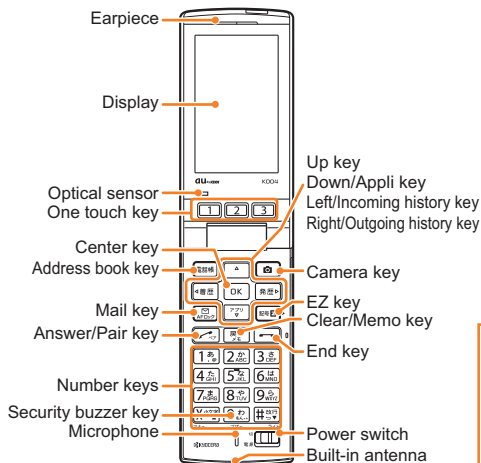

## From the Back

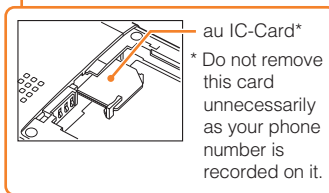
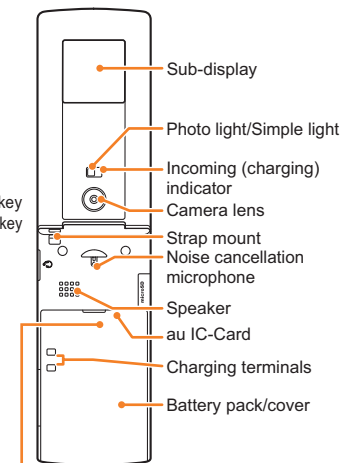

## From the Sides

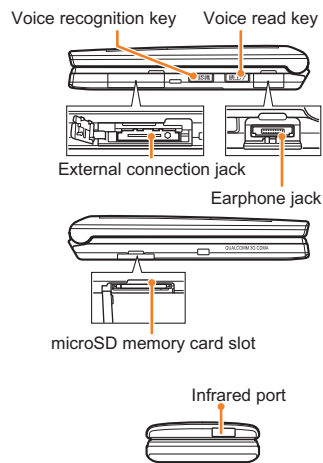

## Charging the Battery Pack

The battery pack is not fully charged at the time of purchase. Be sure to charge the battery pack before using the cell phone for the first time.

- An AC adapter is not included. Purchase a specified AC adapter (sold separately).

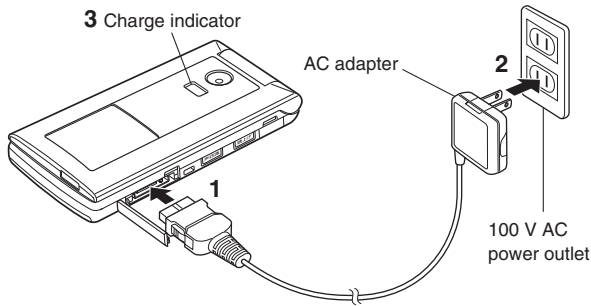

- Be sure to close the cover of the external connection jack when charging is finished.
- Do not pull or twist the cover of the external connection jack forcibly.

### ➔ Connect a specified AC adapter to the cell phone with the battery pack attached.

- Open the cover of the external connection jack. Check the shape of the connector of the AC adapter, and plug it straight into the external connection jack.

### ➔ Unfold the power plug of the AC adapter and plug it into a 100 V AC power outlet.

### ➔ Confirm that the charge indicator lights.

- Charging: The charge indicator lights.
- Charging finished: The charge indicator goes out.

# Learning the Basics

## Key Assignments

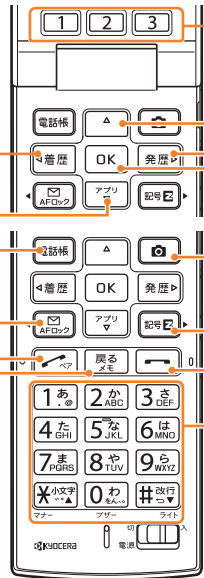

① ② ③ : Use the Pair function.

△ : Display the ticker field/info pane.

◀ 着歴 : Display Incoming History.

▶ 発歴 : Display Outgoing History.

アプリ ▼ : Display EZapps menu.

電話帳 : Use Phone Book.

OK : Display Main menu.

電話帳 △ 写真

カメラ : Active Camera.

✉ : Display EZ Service menu.

✉ : Display E-mail/C-mail menu.

☎ : Make/answer calls.  
Use the Pair function.

☎ : End call/communication.  
Cancel operation.

戻る : Set/cancel Answer memo.  
Delete characters.  
Cancel operation.

○ ~ 9 \* # : Input phone numbers and characters.

## Side Key Assignments

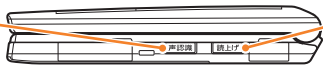

声認識 : Activates voice recognition function (Simple Mode only).

読み上げ : The displayed contents are read out loud (Japanese Mode only).

- If you lose track of where you are or if you make a mistake, press 戻る to return to the previous screen. Press ☎ and return to the standby screen.

## Hiding/Redisplaying the Message Menu

When the message menu is displayed on the standby screen, you can temporarily hide it by pressing and then display the Main menu by pressing .

To redisplay the hidden message menu, press when the standby screen is displayed.

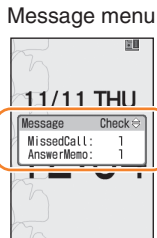

- ➔ Use / to select *Set Language* and then press (選択 [Select]).
- ➔ Use / to select *English* and then press (OK).
- ➔ Use / to select *Alphabet* and then press (OK).

- The K004 default setting is "Simple Mode", but the bilingual function cannot be used in this setting.

## Turning On Power

Slide the power switch toward .

- You cannot receive or make calls if (out of range indicator) is displayed.

## Turning Off Power

Slide the power switch toward .

## Switching the Display Language to English

You can switch the display language for function names and other items to English.

When the standby screen is displayed, press .

- ➔ Use / / / to select *機能設定 (Set Functions)* and then press (選択 [Select]).
- ➔ Use / to select *画面表示 (Screen Setup)* and then press (選択 [Select]).

## Initial Setup of E-mail and EZweb

To use e-mail and EZweb, you need to apply for an EZweb subscription. If you did not apply for an EZweb subscription at the time of purchase, contact an au shop or the au Customer Service Center.

Also, before use, you need to configure initial settings. Your e-mail address is assigned automatically in the initial setup.

**When the standby screen is displayed, press .**



➔ **Press  (OK).**

After a short while, your e-mail address is displayed.

➔ **Press  (OK).**

The initial settings are complete.

- You can also configure initial settings by pressing

 or .

## Checking Your Phone Number and E-mail Address

**When the standby screen is displayed, press  and then .**

# Display Indicators

Display indicators inform you of mail arrival, current settings, etc.

## Display

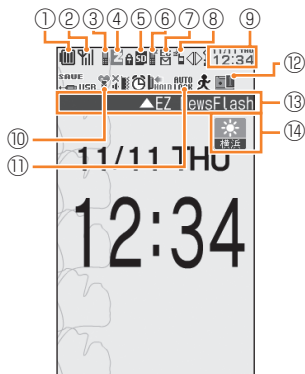

Indicator	Description
①	※ Battery level
②	※ Signal strength
③	During a call
④	Connecting to EZweb EZapps activated
⑤	※ A microSD memory card (commercially available) inserted
⑥	※ Missed calls
⑦	※ New or unread e-mail/C-mail
⑧	Receiving EZ News Flash information
⑨	— Current date and time
⑩	Manner mode set
⑪	AUTO LOCK Auto Lock activated
⑫	Answer memo set
⑬	— Ticker field
⑭	— Info pane

※ The actual display in the standby screen will be larger.

## Sub-display

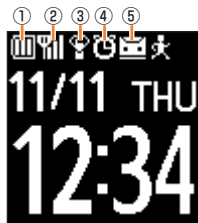

Indicator		Description
①		Battery level
②		Signal strength
③		Manner mode set
④		Alarm set
⑤		Answer memo set

- The date and time are set automatically.

## Using Main Menu

You can access various functions from the Main menu.

Standard Season Flower Shadow
A grid of icons for various functions: Infrared Comm., Camera, microSD, Health Care, Data Folder, Tools, Calculator, Set Functions, and Clock/Calendar. A black bar at the bottom of the grid contains the text "Plays photos and downloaded files".
Screen for Standard.
Infrared Comm.
Camera
microSD
Health Care
Data Folder
Tools
Calculator
Set Functions
Clock/Calendar

## Changing Your E-mail Address

You can change the account name of your e-mail address.

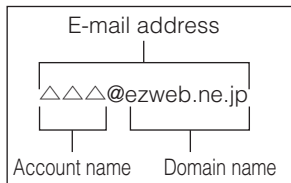

When the standby screen is displayed, press  .

➔ Use  /  to select *E-Mail Setup* and then press  (Select).

➔ Use  /  to select *Other Settings* and then press  (Select).

The cell phone connects to the server.

➔ Use  /  to select *Eメールアドレスの変更* (Change E-mail Address) and then press  (Select).

➔ Use  /  to select the entry box, press  (Edit), enter your security code, and then press  (OK).

- Your security code is the four-digit number you wrote on your subscription form.
- If the security code is incorrectly entered three times consecutively during a single day, the e-mail address change operation will be disabled until the next day.

➔ Use  /  to select *送信* (Send) and then press  (Select).

➔ Use  /  to select *承諾する* (Accept) and then press  (Select).

➔ Use  /  to select the entry box, press  (Edit), enter an e-mail address using single-byte alphanumeric characters, and then press  (OK).

- For details on entering e-mail addresses, see page 22.

➔ Use  /  to select *送信* (Send) and then press  (Select).

➔ Use  /  to select *OK*, press  (Select) and then  (OK).

- Check that the e-mail address has been updated before pressing  (OK).

- Your e-mail address cannot be changed if the new address you enter in the above procedure is already being used. In this case, enter a different e-mail address.



## Security Code and Passwords

You can use a security code and other passwords described below.

Take care not to forget your security code and passwords, because they are required for performing various operations and using subscription services.

### Security Code

Usage Example	<ul style="list-style-type: none"><li>①Using the Answering Service (Voice Mail) and Call Transfer remotely from a fixed-line phone</li><li>②Making inquiries, applications, and changes while using au Customer Service Center voice guidance, au web pages, and EZweb</li><li>③Changing the settings of <i>Mail Filter</i> or <i>Other Settings</i> under E-mail Setup</li></ul>
Initial Setting	The four-digit number you wrote on your subscription form

### Lock No.

Usage Example	Changing various settings of the cell phone
Initial Setting	1234

### EZ Password



Usage Example	Subscribing or canceling subscriptions to EZweb fee-based contents
Initial Setting	The four-digit number you wrote on your subscription form

### Premium EZ Password

Usage Example	<ul style="list-style-type: none"><li>①Subscribing or canceling subscriptions to EZweb fee-based contents paid by <i>まとめてau支払い</i> (au Collective Payment Service)</li><li>②Purchasing products from EZweb sites using <i>まとめてau支払い</i> (au Collective Payment Service)</li></ul>
Initial Setting	The four-digit number you wrote on your subscription form

## Making and Answering Calls

### Making a Call

When the standby screen is displayed, use  to  to enter a phone number.



- When calling to a fixed-line phone, you also need to enter the area code.

➔ Press .

- To end the call, press .

- After you enter a phone number, you can add 184 or 186 to the phone number as follows:

➔ Press  (Call).

➔ Use  /  to select *Call 184* or *Call 186* and then press  (Call).

*184:* When you do not want to inform the other party of your phone number.

*186:* When you want to inform the other party of your phone number.

## Making an International Call

### 001 International Call Service

Available without any additional application

Example: To call 212-123-△△△△ in the USA

Enter the access code, a country code, area code and phone number, and then press .

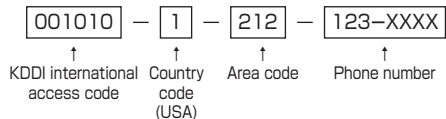

- International call charges are billed together with monthly local call charges.
- For more information on 001 International Call Service, dial either of the following numbers:
  - From au cell phones (toll-free):  
**157** (area code not required)
  - From fixed-line phones (toll-free):  
**0077-7-111**  
(Open 9:00 to 20:00 everyday)

## Answering a Call

To answer a call, press .

- To end the call, press .

### Display When a Call is Received

The phone number of the caller appears.



If the caller's phone number and name are in the phone book, the name is also displayed.

When the phone number of the caller is not displayed, one of the following indicators may appear.

Indicator	Meaning
<i>ID Unsent</i>	The caller did not send a Caller ID.
<i>Payphone</i>	The call is from a pay phone.
<i>Not Support</i>	The call is from a phone that does not support Caller ID.

### Missed Call Notification

If you did not answer a call,  and *MissedCall* are displayed to let you know that you missed a call.



To check the caller's phone number, use  /  to select *MissedCall* and then press  (Check). You can then return the call (see the procedure on the right).

## Returning a Call (Outgoing History/Incoming History)

Example: Returning a call to a phone number in the incoming history

When the standby screen is displayed, press .

- Press  while the standby screen is displayed to display the Outgoing History screen.

➔ Use  /  to select the phone number you want to call and then press  (Detail).

- Press  to display the Outgoing History screen.

➔ Press .

- The cell phone can store up to 50 phone numbers in each of the incoming and outgoing history.

## One-ring Calls

### What is a One-ring Call?



A one-ring call is a call from an unknown caller that only rings once, causing it to be stored in the incoming history. One-ring calls are often used to get you to return the call, which will connect you to a dating service or some other service that charges you at high rates.

### One-ring Indicator

 indicator on the Incoming History screen indicates you have received a one-ring call (a call rang for three seconds or shorter). Be careful when you return a call to an unknown caller.



## Adjusting the Earpiece Volume during a Call

During a call, use  / .

- : Increases the volume.
- : Decreases the volume.



## Turning On Manner Mode

When the standby screen is displayed, hold down  for at least one second.

This turns on manner mode, and displays  on the standby screen. This also turns on Answer memo, which is indicated by  on the standby screen.

### Turning Off Manner Mode

When the standby screen is displayed, hold down  for at least one second.



Turning off manner mode causes  to disappear from the standby screen. Answer memo is also turned off, which is indicated by  disappearing from the standby screen.

- Even in manner mode, the cell phone still emits a sound when autofocusing, a shutter sound when you take a photo.

## Changing the Incoming Ring Tone

When the standby screen is displayed, press .

➔ Use  /  /  /  to select *Set Functions* and then press  (Select).



➔ Use  /  to select *Tone/Vib/Lamp* and then press  (Select).



➔ Use  /  to select *Incoming Setup* and then press  (Select).

➔ Use  /  to select *Incoming Call* and then press  (Select).

➔ Use  /  to select *Melody* and then press  (Select).

➔ Use  /  to select *Fixed RingTone* and then press  (Select).

➔ Use  /  to select *Preset Data* and then press  (Select).

➔ Use  /  to select the ring tone and then press  (OK).

The incoming ring tone is set.

- If you press  (Play), the tone plays.

## Adjusting the Incoming Ring Tone Volume

When the standby screen is displayed, press .

➔ Use / / / to select *Set Functions* and then press (Select).

➔ Use / to select *Tone/Vib/Lamp* and then press (Select).

➔ Use / to select *Incoming Setup* and then press (Select).

➔ Use / to select *Incoming Call* and then press (Select).

➔ Use / to select *Volume* and then press (Select).

➔ Use / to adjust the volume and then press (OK).

- Each press of / changes the volume one step.

<b>STEP UP</b>	The ring tone volume gradually increases.
<b>5 (Deka)</b> (loud) ↓ <b>1 (soft)</b>	The ring tone sounds at the set volume.
<b>OFF</b>	The ring tone does not sound.

## Turning On the Answer Memo

When the standby screen is displayed, hold down for at least one second.

is displayed on the standby screen.

### Turning Off the Answer Memo

When the standby screen is displayed, hold down for at least one second. The answer memo is turned off and disappears from the standby screen.

- The cell phone can record a maximum of ten messages, each up to 60 seconds long.
- Answer memo is a function that automatically answers calls and allows callers to record messages. Use the Answering Service (Voice Mail) when your phone is turned off or when you are in a location where a signal cannot be received.

### Playing a Message

If a message is recorded, *AnswerMemo* appears on the standby screen.

➔ Use / to select *AnswerMemo* and then press (Check).



















➔ Use / to select *Play Memo* and then press (Select).

➔ Use / to select the message you want to play and then press (Play).

- To stop playing the message, press (Stop).

## Deleting a Message

When the standby screen is displayed, press .

- ➔ Use  /  to select *Answer Memo* and then press  (Select).
- ➔ Use  /  to select *Play Memo* and then press  (Select).
- ➔ Use  /  to select the message you want to delete and then press  (Menu).
- ➔ Use  /  to select *Delete* and then press  (Select).
- ➔ Use  /  to select *Delete One* and then press  (Select).
- ➔ Use  /  to select *YES* and then press  (OK).

# Character Input

## Character Entry Modes

When a character entry screen is displayed, you can select a character entry mode if you press  (ChrTyp).

### Menu Items

漢あ : Kanji/hiragana mode

カナ : Double-byte katakana mode





か : Single-byte katakana mode

Aa : Double-byte alphanumeric mode

Aa : Single-byte alphanumeric mode

12 : Double-byte number mode

12 : Single-byte number mode













Use  /  /  /  to select a character entry mode and then press  (Select).

## Entering Alphanumeric Characters

You can use the keys  to  to enter characters.

More than one character is assigned to each key.

The following table shows the key assignment for entering characters.

Key	Number of Times to Press the Key								
	1	2	3	4	5	6	7	8	9
	.	@	-	_	/	:	~	1	
	a	b	c	A	B	C	2		
	d	e	f	D	E	F	3		
	g	h	i	G	H	I	4		
	j	k	l	J	K	L	5		
	m	n	o	M	N	O	6		
	p	q	r	s	P	Q	R	S	7
	t	u	v	T	U	V	8		
	w	x	y	z	W	X	Y	Z	9
	Inputs symbols								0
	Inputs symbols (switches an unconfirmed character between uppercase and lowercase).								
	Adds a line break and displays characters in the opposite order.								

When you change your e-mail address, you cannot use the characters in  for the account name (part of the address to the left of @).

## Entering Two or More Characters Assigned to the Same Key

After you enter the first character, press **発歴▶** and then enter the next character.

## Deleting Characters

To delete one character at a time, move the cursor to the character you want to delete and then press **戻る**. To delete all characters to the right of the cursor, hold down **戻る** for at least one second. If there are no characters to the right of the cursor, holding down **戻る** will delete all the characters.

## Starting a New Line

Press **#**.

- Certain functions such as C-mail do not support entering new lines.

## Entering E-mail Addresses

### E-mail Address Compatible Characters

- Before you enter an e-mail address, switch to the single-byte alphanumeric mode.
- When changing your e-mail address, you can enter up to 30 single-byte alphanumeric and symbol characters for the account name (part to the left of @). Note the following:
  - Uppercase characters cannot be used.
  - Period (.) or zero (0) cannot be used as the first character.

### How to Enter E-mail Addresses

Example: Entering "taro.23@kddi.co.jp"

#### Enter "taro.23".

- t : Press **8** once.  
 a : Press **2** once.  
 r : Press **7** three times.  
 o : Press **6** three times.  
 . : Press **1** once.  
 2 : Press **2** once and then **#**.  
 3 : Press **3** once and then **#**.













#### ➔ Enter "@".

- @ : Press **1** twice.

#### ➔ Enter "kddi".















- k : Press **5** twice.  
 d : Press **3** once and then **発歴▶**.  
 d : Press **3** once.  
 i : Press **4** three times.



- ➔ Press  (Menu).
- ➔ Use  /  to select *Get* and then press  (Select).
- ➔ Use  /  to select *UsefulSentence* and then press  (Select).
- ➔ Use  /  to select *Internet* and then press  (Select).
- ➔ Use  /  to select *.co.jp* and then press  (OK).  
".co.jp" is entered.

## Entering Pictograms

When a character entry screen is displayed, press  (ChrTyp).

- ➔ Use  /  /  簡歴 /  発歴▶ to select   and then press  (Select).
- ➔ Use  /  /  簡歴 /  発歴▶ to select the pictogram you want to enter and then press  (OK).
  - You can enter pictograms consecutively if you press  (Continue) instead of  (OK).

# Phone Book

## Saving a Phone Book Entry





When the standby screen is displayed, hold down  for at least one second.

➔ Use  /  to select  [Name] and then press  (Edit).

➔ Enter a name and then press  (OK).  
The  [Reading] for the name is entered automatically.



➔ Use  /  to select  [Phone No.1] and then press  (Edit).

➔ Enter a phone number and then press  (OK).  
• If the phone number is for a fixed-line phone, enter the phone number starting with the area code.

➔ Use  /  to select a phone number type and then press  (OK).  
• Follow the next step to enter an e-mail address. If you do not want to enter an e-mail address, press  (Comp).

➔ Use  /  to select  [E-Mail Address1] and then press  (Edit).

➔ Enter an e-mail address and then press  (OK).

➔ Use  /  to select an e-mail address type and then press  (OK).



➔ Press  (Comp).

- The phone book can store up to 1,000 entries.
- The cell phone automatically saves an entry to the lowest available memory number from 000 to 999.
- You can save three phone numbers and three e-mail addresses for each phone book entry.
- You can also assign a group No., and enter birthday, address, and other information.

## Dialing from the Phone Book

When the standby screen is displayed, press .

➔ Use  /  /  着歴 /  発歴▶ to select the entry containing the phone number you want to dial and then press  (Detail).

➔ Use  /  to select the phone number and then press  (Select).

➔ Use  /  to select *Call* and then press  (Call).

## Editing Phone Book Entries

When the standby screen is displayed, press .

➔ Select an entry and press  (Detail).



➔ Press  (Edit).

➔ Edit the contents and then press  (Comp).



➔ Use  /  to select *YES* and then press  (OK).



## Saving a Phone Number from the Incoming or Outgoing History

Example: Saving a phone number from the incoming history to the phone book

When the standby screen is displayed, press  and use  /  to select the phone number you want to save.

➔ Press  (Menu).

➔ Use  /  to select *Add to Adr Bk* and then press  (Select).

➔ Use  /  to select *New* and then press  (Select).

➔ Use  /  to select a phone number type and then press  (OK).

- For details on saving a phone book entry, see page 24.

## Pair Function

You can register a maximum of three pair partners you contact often to easily call or send mail.

### Registering a Pair Partner

When the standby screen is displayed, press

**1** / **2** / **3**.

→ Use **▲** / **▼** to select *YES* and then press **OK** (OK).

→ Use **▲** / **▼** / **◀** / **▶** to select a pair partner, press **📷** (Detail) and then **OK** (OK).

- When registering a phone book entry with multiple phone numbers and e-mail addresses as pair partner, select the phone number and e-mail address to use with the Pair function.
- When you delete a phone book entry registered in the pair partner, the phone book entry is also deleted from the Pair function.

### Making a Call to a Pair Partner

When the standby screen is displayed, press

**1** / **2** / **3**.

→ Press **📞**.

### Sending Mail to a Pair Partner

When the standby screen is displayed, press **📧**.

→ Use **◀** / **▶** to select the person you want to send mail.

→ Use **▲** / **▼** to select *Send E-Mail* or *Send C-Mail* and then press **OK** (Select).

- To create an e-mail message, see "Creating and Sending E-mail Messages" on page 27. To create a C-mail message, see "Creating and Sending C-mail Messages" on page 30.

## Using E-mail



























To use e-mail, you need to apply for an EZweb subscription. If you did not apply for an EZweb subscription at the time of purchase, contact an au shop or the au Customer Service Center. Also, before use, you need to configure initial settings.

You can send and receive e-mail with other cell phones that support e-mail, and with PCs. In addition to text messages of up to 5,000 double-byte (or 10,000 single-byte) characters, you can also send photos and movies by e-mail.

- The packet communication charge for sending and receiving e-mail applies to the amount of data sent and received.
- You can send an e-mail message to up to 30 different addresses at one time.
- You can send up to 1,000 e-mail messages per day (a message with multiple recipients is counted as more than one message).
- Sending and receiving e-mail messages that include attachment data may take a while.



## Creating and Sending E-mail Messages

When the standby screen is displayed, press .



- ➔ Use  /  to select *Create New E-Mail* and then press  (Select).
- ➔ Use  /  to select *Destination* and then press  (Edit).
- ➔ Use  /  to select *Get Adr Bk (1)* and then press  (Select).
- ➔ Use  /  /  着歴 /  発歴▶ to select a phone book entry and then press  (OK).
- ➔ Use  /  to select an address and then press  (OK).
- ➔ Use  /  to select *Subject* and then press  (Edit).
- ➔ Enter a subject and then press  (OK).
  - You cannot enter single-byte katakana characters or a new line in a subject.
- ➔ Use  /  to select *Body* and then press  (Edit).
- ➔ Enter text and then press  (OK).
  - You cannot enter single-byte katakana characters.
- ➔ Press  (Send).



## Reading Received E-mail Messages

When you receive an e-mail message, *New E-Mail* appears on the standby screen.





➔ Use  /  to select *New E-Mail* and then press  (Check).

➔ Press  (Select).

- : Indicates a read message.
- : Indicates an unread message.

➔ Use  /  to select the new message and then press  (View).

### Reading an E-mail Message from the E-mail Menu



When the standby screen is displayed, press  to display the E-mail menu, use  /  to select *Inbox* and then press  (Select).



For subsequent operations, see "Reading Received E-mail Messages" above.

## Reading an E-mail Message with an Attached Photo or Movie

Example: Viewing an attached photo

Display the e-mail message that has an attached photo (above).

➔ Use  /  to select the file name and then press  (Select).

➔ Use  /  to select the file name and then press  (Receive).

➔ Press  (Play).



- Selecting the file name or pressing  (Receive) may be unnecessary for some files to be displayed, depending on the file size.

## Replying to Received E-mail Messages

When the standby screen is displayed, press .

➔ Use  /  to select *Inbox* and then press  (Select).

➔ Press  (Select).

➔ Use  /  to select the message you want to reply to and then press  (View).

➔ Press  (Reply).

"Re:" is prefixed to the subject, and the text of the message is quoted.

➔ Refer to "Creating and Sending E-mail Messages" (page 27) for subsequent operations.



















## Rejecting Spam

Setting mail filters to reject spam is recommended. The サポート設定 (Supportive Settings) helps you to set mail filters easily by answering questions that appear on the screen.

### Setting Mail Filters

Example: Connecting to サポート設定 (Supportive Settings)

When the standby screen is displayed, press .

- ➔ Use  /  to select *E-Mail Setup* and then press  (Select).
- ➔ Use  /  to select *Mail Filter* and then press  (Select).
- ➔ Use  /  to select *次へ (Next)* and then press  (Select).
- ➔ Use  /  to select the input box and then press  (Edit).
- ➔ Enter your security code and then press  (OK).
- ➔ Use  /  to select *送信 (Send)* and then press  (Select).
- ➔ Use  /  to select *サポート設定 (Supportive Settings)* and then press  (Select).

## ■ カンタン設定 (Simple Settings)

サポート設定 (Supportive Settings)	Set the filter by answering questions This is recommended for users who want to configure settings while confirming conditions.
フィルターレベル (高) Filter Level (High)	Shut out all mail from PCs This is recommended for users who only want to send mail to and receive mail from cell phones.
フィルターレベル (中) Filter Level (Medium)	Block unsolicited advertisement, spoof e-mail and mail from specific addresses This is recommended for users bothered by certain senders or spam mail.
フィルターレベル (低) Filter Level (Low)	Block unsolicited advertisement and spoof e-mail This is recommended for users who wish to use the minimum filter setting.

- You can also prevent spam by changing your e-mail address. For details on changing your e-mail address, see page 14.

## Using C-mail

C-mail is a service that uses phone numbers as addresses to exchange messages between au cell phones that support C-mail. A C-mail message can contain up to 50 double-byte (or 100 single-byte) characters.

- The C-mail send charge applies when sending C-mail.















### C-mail Safety Block









C-mail safety block is a function that allows you to reject C-mails that include URLs (<http://△△△>, <https://△△△>) or phone numbers in the C-mail message text.

C-mail safety block is valid by default. Cancel the setting if you want to receive C-mails that include URLs and phone numbers in the message text.

## Creating and Sending C-mail Messages













When the standby screen is displayed, hold down  for at least one second.

- ➔ Use  /  to select *Create New C-Mail* and then press  (Select).
- ➔ Use  /  to select  [*Destination*] and then press  (Edit).
- ➔ Use  /  to select *Get AddressBook* and then press  (Select).
- ➔ Use  /  /  /  to select a phone book entry and then press  (OK).

- ➔ Use  /  to select a phone number and then press  (OK).
- ➔ Use  /  to select  [*Body*] and then press  (Edit).
- ➔ Enter text and then press  (OK).
- ➔ Press  (Send).

## Reading Received C-mail Messages

When you receive a C-mail message, *New C-Mail* appears on the standby screen.

- ➔ Use  /  to select *New C-Mail* and then press  (Check).
    - : Indicates a read message.
    - : Indicates an unread message.
  - ➔ Use  /  to select the new message and then press  (View).
- Reading a C-mail Message from the C-mail Menu
- When the standby screen is displayed, hold down  for at least one second to display the C-mail menu, use  /  to select *Inbox* and then press  (Select). For subsequent operations, see "Reading Received C-mail Messages" above.



## Camera

Your cell phone has a CMOS camera with 1.97 effective megapixels for shooting photos and movies. You can use the self-timer and autofocus.

Shot images can be used for the standby screen, and attached to e-mail messages.

## Photo Taking Tips

When taking photos, position the cell phone so that  is not displayed upside down or inclined. Frame the subject within the display and hold the cell phone steady with both hands to avoid shaking.

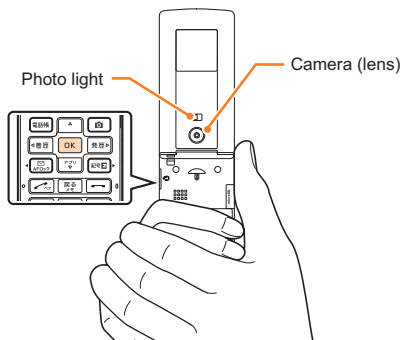

## About Photo Modes

The following modes are available for taking photos.

Mode	Photo Size	Storage Location
Wallpaper	Wallpaper	The <i>Photo Folder</i> in the Data Folder of the cell phone
	Wallpaper (Wide)	
Camera	0.3M	The <i>Camera Folder</i> in the Data Folder of a microSD memory card*
	1M	
	2M	

\* When a microSD memory card (commercially available) is not inserted, the files are saved to the Data Folder of the cell phone.

- Take care not to cover the lens with a strap or finger.

## Taking a Photo

When the standby screen is displayed, press .

The monitor screen appears.

➔ **Point the AF frame at the subject and then press  (Shoot).**

The camera focuses automatically and the shutter clicks. The preview screen is displayed.

## Saving a Photo

Press  (Save) on the preview screen.

- If you do not want to save the photo, press  in the preview screen.

## Viewing Photos

When the standby screen is displayed, press .

- ➔ Use  /  /  /  to select *Data Folder* and then press  (Select).
- ➔ Use  /  to select *Photo Folder* and then press  (Select).
- ➔ Use  /  to select a folder and then press  (Select).
- ➔ Use  /  /  /  to select the photo you want to view and then press  (Play).

EZweb is an information service that allows you to enjoy browsing the Internet on your cell phone. You can also download, Chaku-Uta®, news, and other contents from web pages.

To use EZweb, you need to apply for an EZweb subscription. If you did not apply for an EZweb subscription at the time of purchase, contact an au shop or the au Customer Service Center. Also, before use, you need to configure initial settings.

- The packet communication charge for EZweb connection applies to the amount of data sent and received, not to the length of time connected.
- In addition to communication charges, some sites charge for providing information.

# Accessing Sites

## ■ Viewing the au one Top

You can access EZweb from the au one Top. A variety of useful and fun sites are available on EZweb.

When the standby screen is displayed, press **[E]**, use **[▲]** / **[アフリ]** to select *Top Menu/Search* and then press **[OK]** (Select).



### 便利なメニュー (Quick Menus)

Allows direct access to news, sports, weather, and train connections as well as the au Customer Support page.

### おすすめ! 大人の情報 (Hot! Adult Information)

Introduces information on entertainment, lifestyle, and content aimed at adults.

### キーワード検索機能 (Search by Keyword)

Provides a search function for searching for information by keyword.

### カテゴリ (メニューリスト) から検索する (Category (Menu List) Search)

Provides a list of various content provider sites.

### auのサービス (au Services)

Allows direct access to LISMO!, au Smart Sports, and other popular services as well as the au web site.

### au one ID

Obtains an ID for using services such as *au one メール* (au one Mail) and *au one 乗換* (au one Train Connections) on your PC.

### 災害用伝言板 (Disaster Message Board)

Register and confirm safety information in time of disaster.

### トップページを切り替える (Switch Top Page)

Switches to another au one Top.

## Basic Operations

Use / to select the site you want to access and then press (Select).

Press to return to the previous screen. Hold down for at least one second to return to the au one Top.

The following describes the basic operations that are available while accessing sites.

Key Operation	Description
	Exits EZweb.
/	Moves the cursor up and down. When there is data available above or below the current screen, scrolls up and down the screen one line at a time.
/	When there is data available above or below the current screen, scrolls the screen page by page. : Scrolls one page up. : Scrolls one page down.
	Returns to the previous screen.

## Bookmarking Frequently Accessed Pages

When the page you want to bookmark is displayed, press (Brow. Menu).

→ Use / to select *New bookmark* and then press (Select).

- Some pages cannot be bookmarked.

→ Press (Reg).

The displayed page is bookmarked, and its title and URL are added to the Bookmark.

- The Bookmark can contain up to 100 titles and URLs.

## Viewing Bookmarked Pages

When the standby screen is displayed, press and then use / to select *EZweb*.

→ Use / to select *Bookmark* and then press (Select).

→ Use / to select the bookmark for the page you want to view and then press (Select).

The cell phone connects to the site.

## Checking Charges

When the standby screen is displayed, press **OK**.

➔ Use **▲** / **アプリ** / **▼** / **◀ 着歴** / **発歴 ▶** to select *Set Functions* and then press **OK** (Select).

➔ Use **▲** / **アプリ** / **▼** to select *Time/Toll/Subs* and then press **OK** (Select).

➔ Use **▲** / **アプリ** / **▼** to select *Inquiry Toll* and then press **OK** (Connect).

➔ Press **OK** (OK).

- Select the item you want to check and then follow the on-screen instructions.

## Downloading Chaku-Uta®

When the standby screen is displayed, press **E** and then use **◀ 着歴** / **発歴 ▶** to select *EZweb*.

➔ Use **▲** / **アプリ** / **▼** to select *Top Menu/Search* and then press **OK** (Select).

➔ Use **▲** / **アプリ** / **▼** to select *カテゴリ (メニューリストから検索する)* (Category (Menu List)) and then press **OK** (Select).

➔ Use **▲** / **アプリ** / **▼** to select *着うた (Chaku-Uta®)* and then press **OK** (Select).

➔ Use **▲** / **アプリ** / **▼** to select the site you want to access and then press **OK** (Select).

The download instructions appear.

- Fee-based information sites require entry of EZ password or Premium EZ password. Follow the on-screen instructions to enter either password. See page 15 for details.

➔ Follow the on-screen instructions.

Download is completed.

- Downloaded data is saved automatically to the Data Folder.

➔ Press **電話帳** (Play).

The downloaded Chaku-Uta® plays.

- This procedure is only an example for the purpose of explanation and may differ from actual procedures. Follow the instructions on the site from which you want to download the data.

## EZ News Flash

EZweb Subscription Required

Use the EZ News Flash to display flash news on the standby screen. You can check the news details and other information by selecting the ticker field.

You can use the EZ News Flash by making a few simple settings following the EZweb initial setup.

### Basic Operations

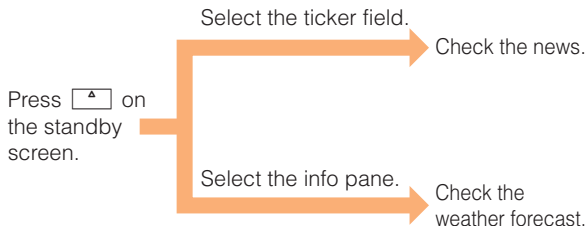

- The EZ News Flash information is automatically received at no charge. Note, however, that packet communication charges may be incurred for manual updates and connecting to EZweb sites. In this case, a confirmation screen for network connection is displayed.
- The EZ News Flash information is updated at regular time intervals.  appears while receiving information.

## Setting EZ News Flash

The EZ News Flash is available free of charge. You have only to make a few simple settings. After following the procedure in “Initial Setup of E-mail and EZweb” on page 11, configure EZ News Flash settings. If you did not configure the EZ News Flash settings at the time of the initial setup, follow the steps below.

**When the standby screen is displayed, press  and select the ticker field and then press  (OK).**

### ➔ Follow the on-screen instructions.

The setup procedure is completed.

- When the standby screen returns, a message asking you to wait for a while until the next update takes place appears in the ticker field.

## ■ Canceling EZ News Flash

When the standby screen is displayed, press  and select the ticker field and then press  (OK).

➔ Press  (メニュー[Menu]), use  /  to select サービス設定解除 (Service Cancellation) and then press  (選択[Select]).

➔ Follow the on-screen instructions.

## ■ Changing the Reception Settings for EZ News Flash Information

You can change the ring tone, vibrator and LED settings under M215 *NewsFlash Rcv* for reception of EZ News Flash information.

If you do not want the ring tone to sound when receiving EZ News Flash information, set the volume to *OFF*.



Using GPS (Global Positioning System), EZ Navi provides useful positional information services.

**When the standby screen is displayed, press  and then use  /  to select the EZnavi.**

- The packet communication charges for using EZ Navi services apply to the amount of data sent and received. Some services may require a separate information fee.
- Before using EZ Navi, you must configure initial settings of EZweb (page 11).

## Passenger Seat Navi for People in the Passenger Seat to Check the Route

Passenger Seat Navi guides the passengers to the destination with the best route using voice and map.

Drivers are not allowed to use Passenger Seat Navi.

## Security Navi to Check Where Your Kids Are

The Security Navi application is made up of the following three functions:

いつでも位置確認 (Auto Position Search [monthly charge]),  
エリア通知 (Area Message [no monthly charge]),  
位置確認メール (Position Search Mail [no monthly charge])

Using these functions, you can check the position of an au cell phone that supports Security Navi; and automatically send a notification to the specified au cell phones when you enter (or are in) or leave (or are no longer in) the set area within a predetermined period of time.

## EZ Navi Walk for When You Go Out

Displays various useful menu items for when you are out. There are two menu modes: the Full Mode menu for those who want to use all the convenient functions including the latest features, and the Simple Mode menu with limited functions allowing you to use the service with simple operation.

The following table describes the Full Mode menu.

フリーワード検索 (Free Word Search)	Search by entering names of facilities and stores, or key words of stations and addresses.
トータルナビ／地図 (Total Navigation/Map)	Find the most preferable combination of transportation (trains, airplanes, buses and taxis), and check out maps of your current location and places you like to go.
乗換／時刻表 (Connection/Timetable)	Search for train connections, timetables and other public transportation information.
お店／施設／イベント (Shop/Facility/Event)	Search for local stores, facilities or events.
ドライブ／渋滞情報 (Road/Traffic Information)	Check out road traffic information in real time.
オススメ便利メニュー (Useful Menu)	View information on services that are available on PCs, and use advanced functions of EZ Navi Walk that you can enjoy.
設定／会員登録／インフォ (Setting/Membership Registration/Information)	Configure various settings, sign up as a member or check out various useful information.

- Some of the menu options require a monthly charge.

### View Your Current Location



★ represents your initial location. As you start moving, changes of your location are tracked by continuous positioning and indicated in real time by 🧑.

The *現在地の地図* (View Your Current Location) option displays the current map in real time.

### 3D Navi

Shows a 3D view at guidance points and around the destination area.

## Evacuate Navi to Guide You Home or to Nearby Evacuation Areas during Disasters

Nearby public evacuation areas or the direction to your home can be determined using the map data pre-installed on the K004 (避難所マップ[Evacuate Area Map] ). Other useful contents can be downloaded from the 災害時ナビ(Evacuate Navi) section of the EZweb site.

- Some contents require a monthly charge.
- Use the information on the screen as a reference and always follow the instructions of police, fire and other municipal authorities.

## In Case of Loss of Your K004

The Remote Ctrl Lock allows you to remotely activate the Auto Lock, and Address Book Lock, preventing others from using your cell phone.

### Setting Conditions for Activating the Remote Ctrl Lock

You can activate the Remote Ctrl Lock by calling your K004 a set number of times from a registered phone number within a specified period of time.

When the standby screen is displayed, press .

- ➔ Use  /  /  /  to select *Set Functions* and then press  (Select).
- ➔ Use  /  to select *Priv/Restrict* and then press  (Select).
- ➔ Use  /  to select *Security Lock* and then press  (Select).
- ➔ Use  /  to select *Remote Lock* and then press  (Select).
- ➔ Enter Lock No., and then press  (OK).
- ➔ Use  /  to select *ON/OFF Setup* and then press  (Select).
- ➔ Use  /  to select *ON* and then press  (OK).

- ➔ Use  /  to select *Caller No.List* and then press  (Select).
- ➔ Use  /  to select *00* and then press  (Edit).
- ➔ Use  /  to select *Input Phone No.*, press  (Select), enter a phone number, and then press  (OK).
- ➔ Press  (Back).
- ➔ Use  /  to select *Set Time* and then press  (Select).
- ➔ Enter a time and then press  (OK).
  - This sets the time limit for receiving the set number of calls after the first call is received.
  - You can set a time from one to ten minutes.
- ➔ Use  /  to select *No. of Calls*, and then press  (Select).
- ➔ Enter a number of calls, and then press  (OK).
  - This sets the number of calls to receive to activate the Remote Ctrl Lock.
  - You can set a number of calls from five to ten.

## Remotely Activating the Remote Ctrl Lock on Your K004

Call the K004 from the registered phone number repeatedly within the set time limit.

- When the specified number of calls are received, the Remote Ctrl Lock is activated and a message plays telling you that the cell phone is locked.

## Activating the Remote Ctrl Lock by the Security Lock Service

Even if the Remote Ctrl Lock is not set in advance, the Remote Ctrl Lock can be activated by calling au Customer Service Center or completing the application process on au Customer Support from a PC.

The Security Lock Service is available free of charge.

## Calling au Customer Service Center for Activating/Canceling the Remote Ctrl Lock

From an au cell phone: 113 without a prefix (toll free)

From any other cell phone or fixed-line phone:

 0077-7-113 (toll free)

Open 24 hours

Follow the voice guidance to complete the application process.





## Activating/Canceling the Remote Ctrl Lock from a PC

Login to au Customer Support (<https://cs.kddi.com/>) and complete the application process by following the on-screen instructions.

- The Remote Ctrl Lock cannot be activated when the K004 is turned off or out of the service area, or Emission OFF is set.
- You must fill out an application to use au Customer Support (the application can be filled out even after your cell phone is lost).

# Troubleshooting

Symptom	Possible Cause	Remedy	Page
Cannot turn on power.	● Is the battery pack charged?	Charge the battery pack.	8
	● Did you slide the power switch toward 入?	Slide the power switch toward 入.	10
Cannot make calls.	● Is power turned on?	Slide the power switch toward 入.	10
	● Is <sup>Out of</sup> Range (out of range indicator) displayed?	Move to a location where <sup>Out of</sup> Range (out of range indicator) is no longer displayed, and try again.	12
	● Is your hand or a metal object covering the area around the built-in antenna?	Make sure your hand or any other metal object is not covering the area around the built-in antenna.	7
	● Did you enter the phone number starting with the area code?	When making a call to a phone other than a cell phone, you need to enter the area code even if you are inside the same area.	16
Cannot receive calls.	● Is <sup>Out of</sup> Range (out of range indicator) displayed?	Move to a location where <sup>Out of</sup> Range (out of range indicator) is no longer displayed.	12
	● Is power turned on?	Slide the power switch toward 入.	10
No response when a key is pressed.	● Is power turned on?	Slide the power switch toward 入.	10
A warning tone sounds and power turns off.	● Is there enough power left in the battery pack?	Charge the battery pack.	8
Calls are answered automatically.	● Is Answer memo turned on?	Hold down [戻る] for at least one second to turn off Answer memo.	19

Symptom	Possible Cause	Remedy	Page
Cannot hear the other party.	● Is the earpiece volume too low?	Press  during a call to increase the earpiece volume.	18
When making a call, a beeping sound is heard from the earpiece and a connection cannot be established.	● Is  (out of range indicator) displayed? Or are you in a location where the signal is too weak?	Move to a location where  (out of range indicator) is no longer displayed.	12
	● Is the wireless line busy or is the phone you are calling on another line?	End the call and try again later.	16
The incoming LED flashes but the ring tone does not play.	● Is manner mode turned on?	Hold down  for at least one second to turn off manner mode.	18
	● Is  (ring tone off indicator) displayed?	Increase the volume of the incoming call ring tone.	19
Cannot charge the battery pack.	● Is the battery pack installed properly?	Install the battery pack properly.	8
	● Are the plug and connector of the AC adapter inserted properly?	Insert the plug and connector firmly.	
When the camera is activated, no subject is displayed.	● Is a finger or other object covering the camera (lens)?	Check the position of the camera (lens) and remove the obstacle.	31

- For more detailed information, visit the following au troubleshooting sites:
  - From an au cell phone:  ⇒ *Top Menu/Search* ⇒ *auお客様サポート* (au Customer Support) ⇒ *オンラインマニュアル* (Online Manual) ⇒ *故障診断Q&A* (Troubleshooting FAQ)
  - From a PC: <http://www.kddi.com/customer/service/au/trouble/kosho/index.html>

# Index

## A

Accessories .....	6
Answer memo .....	19
Playback .....	19
Turning off .....	19
Turning on .....	19

## B

Battery level .....	12
Battery pack .....	6,8
Battery pack cover .....	7

## C

Camera .....	31
Photo taking tips .....	31
Taking a photo .....	31
Cell phone etiquette .....	2
Character input .....	21
Character entry modes .....	21
Deleting characters .....	22
Entering characters from the same key .....	22
Starting a new line .....	22
Charging the battery pack .....	8
Checking charges .....	36
C-mail .....	30
C-mail safety block .....	30
Creating and sending .....	30

Reading Received mail .....	30
Contents .....	4

## D

Disaster Message Board Service .....	3
Display .....	7,12
Domain .....	14
Downloading Chaku-Uta® .....	36

## E

Earpiece volume .....	18
E-mail .....	27
Creating and sending .....	27
Initial settings .....	11
Reading Received mail .....	28
Replying .....	28
Viewing attached images .....	28
E-mail address .....	11
Available characters .....	21
Changing .....	14
Entering .....	22
Entering pictograms .....	23
Evacuate Navi .....	41
EZ Navi .....	39
EZ Navi Walk .....	40
EZ News Flash .....	37
Canceling .....	38
Changing the Reception Settings .....	38
Info pane .....	37
Setting .....	37



Ticker field .....	37
EZ password .....	15
EZweb .....	33
Accessing sites .....	34
au one Top .....	34
Basic operations .....	35
Initial settings .....	11

## I

Incoming history .....	17
Indicators .....	12
Initial settings .....	11
E-mail · EZweb .....	11
International Call .....	16
Internet .....	33
Sites .....	34,35

## K

Key assignments .....	9
-----------------------	---

## L

Language .....	10
Learning the basics .....	9
Lock No. ....	15

## M

Mail .....	27
C-mail .....	30
E-mail .....	27

Mail filters .....	29
Simple settings .....	29
Main menu .....	13
Manner mode .....	18
Message Menu .....	10

## N

Names of parts .....	7
----------------------	---

## O

One-ring calls .....	17
Outgoing history .....	17

## P

Pair Function .....	26
Making a call to a pair partner .....	26
Registering a pair partner .....	26
Sending mail to a pair partner .....	26
Passenger Seat Navi .....	39
Passwords .....	15
Phone (call) .....	16
184/186 .....	16
Answering .....	17
International Call .....	16
Making .....	16
Returning .....	17
Phone book .....	24
Dialing .....	24
Editing .....	24
Saving .....	24

Saving a phone number from the incoming or outgoing history	25
Phone number	11
Photos	31
Photo modes	31
Taking	31
Viewing	32
Playback	
Answer memo	19
Premium EZ password	15

## R

Remote Ctrl Lock	42
Ring tones	
Changing the type	18
Changing the volume	19

## S

Security code	15
Security Lock Service	43
Security Navi	39
Signal strength	12
Sites	34
Bookmarking	35
Viewing from bookmarks	35
Spam	29
Sub-display	13

## T

Troubleshooting	44
Turning on/off power	10

## V

Viewing	
Photos	32

For inquiries, call: au Customer Service Center

For general information and charges (toll free)

From fixed-line phones:  
 0077-7-111

From au cell phones:  
157 area code not required

PRESSING ZERO WILL CONNECT YOU TO AN OPERATOR  
AFTER CALLING 157 ON YOUR au CELL PHONE

For loss, theft or damage and operation information  
(toll free)

From fixed-line phones:  
 0077-7-113

From au cell phones:  
113 area code not required

In case above numbers are not available,

 0120-977-033 (except Okinawa)

 0120-977-699 (Okinawa)

From EZweb:

Access Method

EZ ▶ Top Menu/Search ▶ auお客様サポート (au Customer Support)  
▶ お問い合わせ (Inquiries)

• Menu are subject to change without prior notice.

なるほど! au  
みんなでつくる、auQ&Aサイト

Access Method

EZ ▶ Top Menu/Search ▶ auお客様サポート (au Customer Support)  
▶ みんなでQ&A「なるほど! au」 (au User's Forum)

Read this code for an easy  
access to なるほど! au  
(au User's Forum). ▶

• The packet communication  
charge applies.



Cell phone and PHS operators collect and recycle unused  
telephones, batteries and battery chargers at stores  
bearing the ♻️ logo regardless of brand and manufacturer  
to protect the environment and reuse valuable resources.

モバイル・リサイクル・ネットワーク  
00661-948-0077-21112076

Read this code for  
an easy access to  
au Online Manual.



January 2010 1st Edition

Sales: KDDI CORPORATION・  
OKINAWA CELLULAR TELEPHONE COMPANY  
Manufactured by: KYOCERA Corporation