

K003

Basic Manual

READ THIS MANUAL TO MASTER
THE CELLULAR PHONE

www.au.kddi.com

Illustrations and
Screenshots
in This Manual

Notes on
Cell Phone Use

Contents

Getting Ready

Making and
Answering Calls

Character Input

Phone Book

Pair Function

Mail

Camera

EZweb

EZ News Flash

EZ Navi

In Case of
Loss of Your K003

Troubleshooting

Index

Introduction

Thank you for purchasing the K003. Before using your K003, be sure to read the K003 Basic Manual (this PDF manual) to ensure correct usage. After you have finished reading this manual, store this PDF manual and the printed manuals in safe places so you can retrieve them whenever you need them.

Manuals for the K003

The K003 comes with the Basic Manual and Instruction Manual.

● For learning the basics:

Read the K003 Basic Manual (this manual).

● For learning details on using each function:

Read the supplied K003 Instruction Manual (Japanese). Be sure to read the Safety Precautions “安全上のご注意” to ensure proper usage of the K003.

The keyword searchable au Online Manual is also available on the au homepage:

<http://www.au.kddi.com/manual/index.html>



- To access from EZweb:  ⇒ *au one Top* ⇒ *auお客さまサポート* (au Customer Support) ⇒ *オンラインマニュアル* (Online Manual)



Scan this QR code to access the au Online Manual. ▶





The K003 default setting, or its setting after being reset, is "Simple Mode". To use K003 with the bilingual function, you must switch it "Normal Mode". Perform the following steps to switch to "Normal Mode". Descriptions in this manual are based on "Normal Mode".

When the standby screen is displayed, press .

➔ Use  /  to select *各種設定* (Set Functions) and then press  (選択 [select]).

➔ Use  /  to select *通常モード切替* (Switch to Normal mode) and then press  (選択 [select]).

➔ Use  /  to select *はい* (Yes) and then press  (OK).

After the K003 is set to "Normal Mode", refer to steps in page 10 to switch to English language mode.

Illustrations and Screenshots in This Manual

Note on Illustrations

The illustrations in this manual may look different from the actual cell phone in shape, color and typeface. The key illustrations are also simplified as shown below.

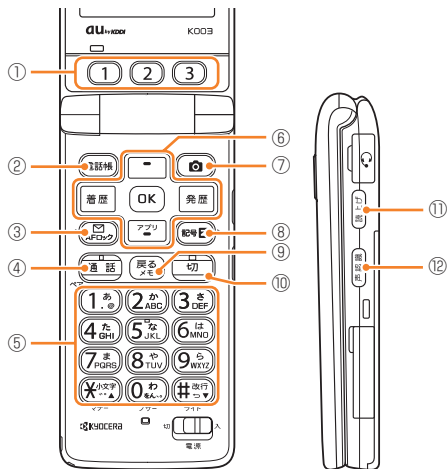

	Key Illustration		Key Illustration
①	① ② ③	⑥	Call Log OK Call Log Apps
②	電話帳	⑦	カメラ
③	メール	⑧	戻る
④	通話	⑨	切
⑤	1 2 3 4 5 6 7 8 9 * 0 #	⑩	切
		⑪	読み上げ
		⑫	声認識

Note on Screenshots

The screenshots in this manual are simplified and may look different from the actual cell phone screens.

Notes on Cell Phone Use

Cell Phone Etiquette

The cell phone always emits weak radio waves when power is on.

Use the cell phone in an enjoyable and safe manner without forgetting to be considerate of others around you.

- **Use of cell phones is not allowed in some places.**
 - Do not use the cell phone while you are driving. Doing so is both dangerous and prohibited by law.
 - Using a cell phone in an aircraft is prohibited by law. Be sure to turn the cell phone power off.
- **Radio waves from cell phones may interfere with medical electrical equipment.**
 - Some people close to you in crowded places such as packed trains may be using a cardiac pacemaker. Turn the cell phone off in such places.
 - Abide by the rules of hospitals and other medical institutions where it is forbidden to use or carry cell phones.
- **Be considerate of where you use the cell phone and how loudly you talk.**
 - Do not make calls in theaters, museums, libraries, and other similar places. Turn power off or turn on manner mode not to disturb others around you by ring tones.
 - Do not use the cell phone on a street where you might interrupt the flow of pedestrians.
 - Move to areas where you will not inconvenience others on trains or in hotel lobbies.
 - Refrain from talking in a loud voice.

- Obtain the permission of other people before you take their photos with the cell phone's camera.
- Do not record information with the cell phone's camera in bookstores and other locations where taking photos is not permitted.

Do Not Use the Cell Phone While Driving!

Turn off your cell phone or put it in Drive Mode while driving.

Do not use the cell phone while driving a car/motorcycle or riding a bicycle. It may result in a traffic accident. Using a cell phone while driving is prohibited by law. Using a cell phone while riding a bicycle may also be punishable by law.

Prohibited!

- Looking at a cell phone display
- Talking on a cell phone while holding it

Drive Mode

In Drive Mode, a Japanese message meaning "I'm driving now, so I can't answer your call." is played when a call is received, and asks the caller to leave a message on the answer memo.

- When the standby screen is displayed, press **OK**,
- ➡ Use **[] / [] / [] / []** to select *Tools* and then press **OK** (select).
 - ➡ Use **[] / []** to select *Manner Mode* and then press **OK** (select).
 - ➡ Use **[] / []** to select *Drive Mode* and then press **OK** (OK).

Disaster Message Board Service

When a large scale disaster occurs, you can register your safety information from EZweb. The registered information can be referred from anywhere in Japan from EZweb or Internet.

Registering safety information

- When a large scale disaster occurs, from an au phone, you can register your safety information (i.e. your condition and comments) to the 災害用伝言板 (Disaster Message Board) created on the EZweb.
- After registration of your safety information, e-mail is sent to your family or acquaintances you have previously designated to notify that your safety information has been uploaded to the 災害用伝言板 (Disaster Message Board).

Inquiring for safety information

- You can inquire for safety information of a person by entering his/her phone number from EZweb or Internet.*
* To inquire from other carriers' cell phone, a PHS or PC, access "<http://dengon.ezweb.ne.jp/>".

Access	 ⇒ <i>au one Top</i> ⇒ 災害用伝言板 (Disaster Message Board)
	http://dengon.ezweb.ne.jp/

- The maximum storage period of the registered information is 72 hours.
- The maximum available number of registrations is 10 per phone number. When the number of registrations exceeds 10, the oldest one is overwritten.
- The demonstration of this service can be referred to anytime by pressing  ⇒ *au one Top* ⇒ *auお客さまサポート* (au Customer Support) ⇒ 調べる (Search) ⇒ 災害用伝言板 (デモ版) (Disaster Message Board (Demo Version)).
- To view the Disaster Message Board in English, select *English* from the top menu of the Disaster Message Board.

Contents

Introduction

Illustrations and Screenshots in This Manual 1

Notes on Cell Phone Use 2

Cell Phone Etiquette	2
Do Not Use the Cell Phone While Driving!.....	2
Disaster Message Board Service	3

Contents 4

Getting Ready 6

Checking the Contents of the Box	6
Names of Parts	7
Charging the Battery Pack	8
Learning the Basics	9
Turning On Power	10
Switching the Display Language to English	10
Initial Setup of E-mail and EZweb	11
Checking Your Phone Number and E-mail Address ...	11
Display Indicators	12
Using Main Menu	13
Changing Your E-mail Address.....	14
Security Code and Passwords.....	15

Making and Answering Calls 16

Making a Call	16
Making an International Call.....	16
Answering a Call.....	17

Returning a Call (Outgoing History/Incoming History) ...	17
One-ring Calls.....	17
Adjusting the Earpiece Volume during a Call.....	18
Turning On Manner Mode.....	18
Changing the Incoming Ring Tone	18
Adjusting the Incoming Ring Tone Volume	19
Turning On the Answer Memo	19

Character Input 21

Character Entry Modes	21
Entering Alphanumeric Characters	21
Entering E-mail Addresses	22
Entering Pictograms	23

Phone Book 24

Saving a Phone Book Entry	24
Dialing from the Phone Book	24
Editing Phone Book Entries	24
Saving a Phone Number from the Incoming or Outgoing History	25

Pair Function 26

Registering a Pair Partner.....	26
Making a Call to a Pair Partner	26
Sending Mail to a Pair Partner.....	26

Mail 27

Using E-mail	27
Creating and Sending E-mail Messages	27
Reading Received E-mail Messages	28
Reading an E-mail Message with an Attached Photo or Movie	28

Replying to Received E-mail Messages	28	In Case of Loss of Your K003	42
Rejecting Spam	29	Setting Conditions for Activating the Remote Ctrl Lock...	42
Using C-mail	30	Remotely Activating the Remote Ctrl Lock	
Creating and Sending C-mail Messages	30	on Your K003	43
Reading Received C-mail Messages	30	Activating the Remote Ctrl Lock	
Camera	31	by the Security Lock Service	43
Photo Taking Tips	31	Troubleshooting	44
About Photo Modes	31	Index	46
Taking a Photo	31		
Viewing Photos	32		
EZweb	33		
Accessing Sites	34		
Bookmarking Frequently Accessed Pages.....	35		
Viewing Bookmarked Pages.....	35		
Checking Charges	36		
Downloading Chaku-Uta®.....	36		
EZ News Flash	37		
Basic Operations	37		
Setting EZ News Flash	37		
EZ Navi	39		
Passenger Seat Navi for People			
in the Passenger Seat to Check the Route	39		
Security Navi to Check Where Your Kids Are.....	39		
EZ Navi Walk for When You Go Out	40		
Evacuate Navi to Guide You Home or to Nearby			
Evacuation Areas during Disasters	41		

Getting Ready

Checking the Contents of the Box

The box contains the cell phone and accessories.

- Cell phone
- Battery pack
- CD-ROM
- Instruction Manual (Japanese)
- Warranty (Japanese)
- Safety Precautions (Japanese)
- JIBUN BANK Launcher Operation Guide (Japanese)
- Global Passport mobile rental service Owner's Guide (Japanese)
- Easy Start Guide (Japanese)

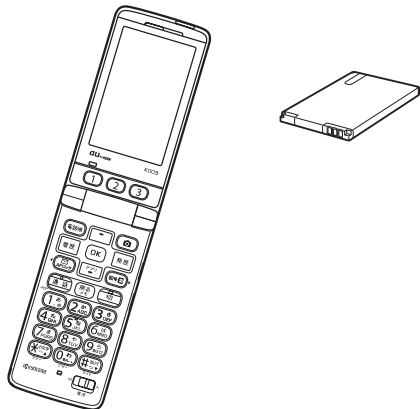

- An AC adapter and microSD memory card are not included. Purchase a specified AC adapter (sold separately) and a commercially available microSD memory card.

Names of Parts

From the Front

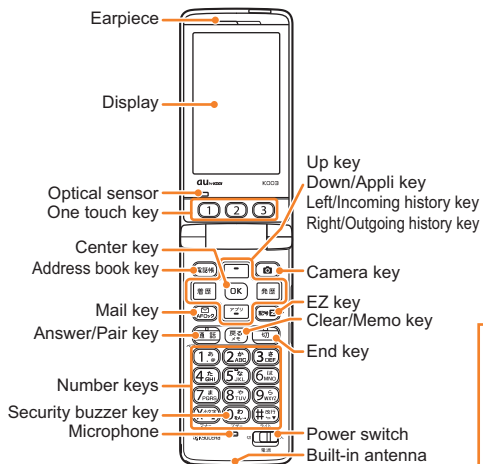

From the Back

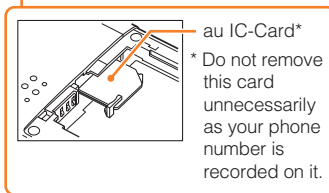
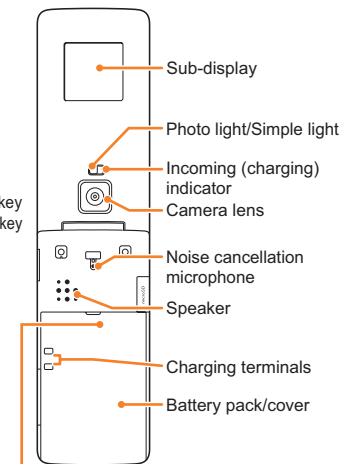

From the Sides

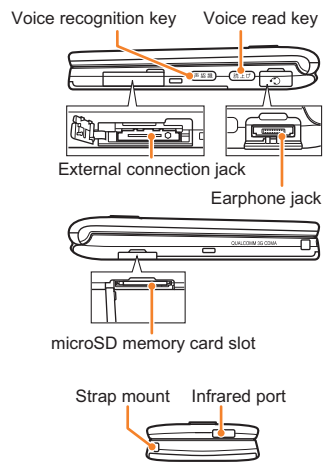

Charging the Battery Pack

The battery pack is not fully charged at the time of purchase. Be sure to charge the battery pack before using the cell phone for the first time.

- An AC adapter is not included. Purchase a specified AC adapter (sold separately).

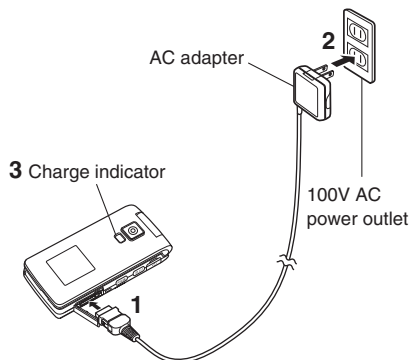

➔ Connect a specified AC adapter to the cell phone with the battery pack attached.

- Open the cover of the external connection jack. Check the shape of the connector of the AC adapter, and plug it straight into the external connection jack.

➔ Unfold the power plug of the AC adapter and plug it into a 100 V AC power outlet.

➔ Confirm that the charge indicator lights.

- Charging: The charge indicator lights.
- Charging finished: The charge indicator goes out.

- Be sure to close the cover of the external connection jack when charging is finished.
- Do not pull or twist the cover of the external connection jack forcibly.

Learning the Basics

Key Assignments

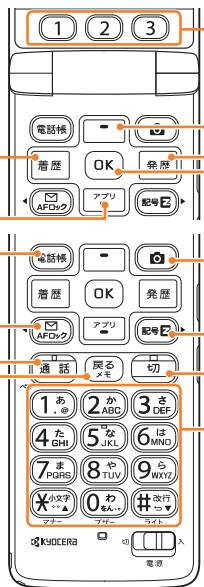

① ② ③ : Use the Pair function.

☰ : Display the ticker field/info pane.

履歴 : Display Incoming History.

履歴 OK 発信 : 履歴 : Display Outgoing History.

アプリ : Display EZapps menu.

電話帳 : Use Phone Book.

OK : Display Main menu.

☑ : Active Camera.

☑ : Display EZ Service menu.

☑ : End call/communication.
Cancel operation.

☑ : Display E-mail/C-mail menu.

☑ : Make/answer calls.
Use the Pair function.

☑ : Set/cancel Answer memo.
Delete characters.
Cancel operation.

0 ~ 9 * # :
Input phone numbers and characters.

Side Key Assignments

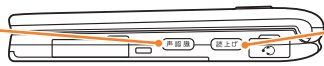

声認識 : Activates voice recognition function (Simple Mode only).

読上げ : The displayed contents are read out loud (Japanese Mode only).

- If you lose track of where you are or if you make a mistake, press 戻る to return to the previous screen. Press 切 and return to the standby screen.

Hiding/Redisplaying the Message Menu

When the message menu is displayed on the standby screen, you can temporarily hide it by pressing **[切]** and then display the Main menu by pressing **[OK]**.

To redisplay the hidden message menu, press **[切]** when the standby screen is displayed.

Message menu

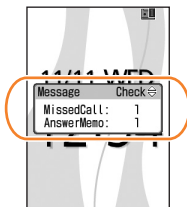

➔ Use **[左]/[右]** to select *Set Language* and then press **[OK]** (選択 [Select]).

➔ Use **[左]/[右]** to select *English* and then press **[OK]** (OK).

➔ Use **[左]/[右]** to select *Alphabet* and then press **[OK]** (OK).

- The K003 default setting is "Simple Mode", but the bilingual function cannot be used in this setting.

Turning On Power

Slide the power switch toward **入**.

- You cannot receive or make calls if **Out of Range** (out of range indicator) is displayed.

Turning Off Power

Slide the power switch toward **切**.

Switching the Display Language to English

You can switch the display language for function names and other items to English.

When the standby screen is displayed, press **[OK]**.

➔ Use **[左]/[右]/[上]/[下]** to select *機能設定* (Set Functions) and then press **[OK]** (選択 [Select]).

➔ Use **[左]/[右]** to select *画面表示* (Screen Setup) and then press **[OK]** (選択 [Select]).

Initial Setup of E-mail and EZweb

To use e-mail and EZweb, you need to apply for an EZweb subscription. If you did not apply for an EZweb subscription at the time of purchase, contact an au shop or the au Customer Service Center.

Also, before use, you need to configure initial settings. Your e-mail address is assigned automatically in the initial setup.



When the standby screen is displayed, press .

➔ **Press  (OK).**



After a short while, your e-mail address is displayed.

➔ **Press  (OK).**

The initial settings are complete.

- You can also configure initial settings by pressing  or .

Checking Your Phone Number and E-mail Address









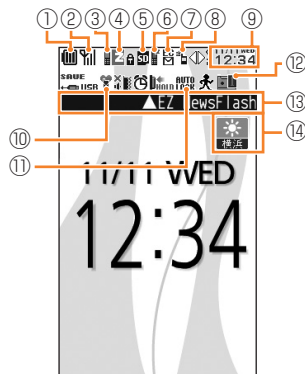



When the standby screen is displayed, press  and then .

Display Indicators

Display indicators inform you of mail arrival, current settings, etc.

Display



Indicator	Description
①	 ※ Battery level
②	 ※ Signal strength
③	 During a call
④	 Connecting to EZweb
	 EZapps activated
⑤	 ※ A microSD memory card (commercially available) inserted
⑥	 ※ Missed calls
⑦	 ※ New or unread e-mail/C-mail
⑧	 Receiving EZ News Flash information
⑨	— Current date and time
⑩	 Manner mode set
⑪	 AUTO LOCK activated
⑫	 Answer memo set
⑬	— Ticker field
⑭	— Info pane

※ The actual display in the standby screen will be larger.

Sub-display



Indicator		Description
①		Battery level
②		Signal strength
③		Manner mode set
④		Alarm set
⑤		Answer memo set

- The date and time are set automatically.

Using Main Menu

You can access various functions from the Main menu.

Standard Season Flower Shadow
A grid of application icons: Infrared Comm., Camera, microSD, Health Care, Data Folder, Tools, Calculator, Set Functions, and Clock/Calendar. Below the grid is a black bar with white text: "Plays photos and downloaded files".
Screen for Standard.
Infrared Comm.
Camera
microSD
Health Care
Data Folder
Tools
Calculator
Set Functions
Clock/Calendar

Changing Your E-mail Address

You can change the account name of your e-mail address.

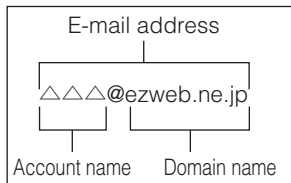

When the standby screen is displayed, press .

➔ Use / to select *E-Mail Setup* and then press (Select).

➔ Use / to select *Other Settings* and then press (Select).

The cell phone connects to the server.

➔ Use / to select *メールアドレスの変更* (Change E-mail Address) and then press (Select).

➔ Use / to select the entry box, press (Edit), enter your security code, and then press (OK).

- Your security code is the four-digit number you wrote on your subscription form.
- If the security code is incorrectly entered three times consecutively during a single day, the e-mail address change operation will be disabled until the next day.

➔ Use / to select *送信* (Send) and then press (Select).

➔ Use / to select *承諾する* (Accept) and then press (Select).

➔ Use / to select the entry box, press (Edit), enter an e-mail address using single-byte alphanumeric characters, and then press (OK).

- For details on entering e-mail addresses, see page 22.

➔ Use / to select *送信* (Send) and then press (Select).

➔ Use / to select *OK*, press (Select) and then (OK).

- Check that the e-mail address has been updated before pressing (OK).

- Your e-mail address cannot be changed if the new address you enter in the above procedure is already being used. In this case, enter a different e-mail address.

Security Code and Passwords

You can use a security code and other passwords described below.

Take care not to forget your security code and passwords, because they are required for performing various operations and using subscription services.

Security Code

Usage Example	<ul style="list-style-type: none">①Using the Answering Service (Voice Mail) and Call Transfer remotely from a fixed-line phone②Making inquiries, applications, and changes while using au Customer Service Center voice guidance, au web pages, and EZweb③Changing the settings of <i>Mail Filter</i> or <i>Other Settings</i> under E-mail Setup
Initial Setting	The four-digit number you wrote on your subscription form

Lock No.

Usage Example	Changing various settings of the cell phone
Initial Setting	1234

EZ Password

Usage Example	Subscribing or canceling subscriptions to EZweb fee-based contents
Initial Setting	The four-digit number you wrote on your subscription form

Premium EZ Password

Usage Example	<ul style="list-style-type: none">①Subscribing or canceling subscriptions to EZweb fee-based contents paid by <i>まとめてau支払い</i> (au Collective Payment Service)②Purchasing products from EZweb sites using <i>まとめてau支払い</i> (au Collective Payment Service)
Initial Setting	The four-digit number you wrote on your subscription form

Answering a Call

To answer a call, press .

- To end the call, press .

Display When a Call is Received

The phone number of the caller appears.



If the caller's phone number and name are in the phone book, the name is also displayed.

When the phone number of the caller is not displayed, one of the following indicators may appear.

Indicator	Meaning
<i>ID Unsent</i>	The caller did not send a Caller ID.
<i>Payphone</i>	The call is from a pay phone.
<i>Not Support</i>	The call is from a phone that does not support Caller ID.

Missed Call Notification

If you did not answer a call,  and *MissedCall* are displayed to let you know that you missed a call.

To check the caller's phone number, use / to select *MissedCall* and then press  (Check). You can then return the call (see the procedure on the right).

Returning a Call (Outgoing History/Incoming History)

Example: Returning a call to a phone number in the incoming history

When the standby screen is displayed, press .

- Press  while the standby screen is displayed to display the Outgoing History screen.

➔ Use / to select the phone number you want to call and then press  (Detail).

- Press  to display the Outgoing History screen.

➔ Press .

- The cell phone can store up to 50 phone numbers in each of the incoming and outgoing history.

One-ring Calls

What is a One-ring Call?



A one-ring call is a call from an unknown caller that only rings once, causing it to be stored in the incoming history. One-ring calls are often used to get you to return the call, which will connect you to a dating service or some other service that charges you at high rates.

One-ring Indicator

 indicator on the Incoming History screen indicates you have received a one-ring call (a call rang for three seconds or shorter). Be careful when you return a call to an unknown caller.



Adjusting the Earpiece Volume during a Call

During a call, use  / .

- : Increases the volume.
- : Decreases the volume.



Turning On Manner Mode

When the standby screen is displayed, hold down  for at least one second.

This turns on manner mode, and displays  on the standby screen. This also turns on Answer memo, which is indicated by  on the standby screen.

Turning Off Manner Mode





When the standby screen is displayed, hold down  for at least one second.

Turning off manner mode causes  to disappear from the standby screen. Answer memo is also turned off, which is indicated by  disappearing from the standby screen.

- Even in manner mode, the cell phone still emits a sound when autofocusing, a shutter sound when you take a photo.

Changing the Incoming Ring Tone

When the standby screen is displayed, press .

➔ Use  /  /  /  to select *Set Functions* and then press  (Select).

➔ Use  /  to select *Tone/Vib/Lamp* and then press  (Select).

➔ Use  /  to select *Incoming Setup* and then press  (Select).

➔ Use  /  to select *Incoming Call* and then press  (Select).

➔ Use  /  to select *Melody* and then press  (Select).

➔ Use  /  to select *Fixed RingTone* and then press  (Select).

➔ Use  /  to select *Preset Data* and then press  (Select).

➔ Use  /  to select the ring tone and then press  (OK).

The incoming ring tone is set.

- If you press  (Play), the tone plays.

Adjusting the Incoming Ring Tone Volume

When the standby screen is displayed, press **OK**.

➔ Use **☰/アプリ/着信/発信** to select *Set Functions* and then press **OK** (Select).

➔ Use **☰/アプリ** to select *Tone/Vib/Lamp* and then press **OK** (Select).

➔ Use **☰/アプリ** to select *Incoming Setup* and then press **OK** (Select).

➔ Use **☰/アプリ** to select *Incoming Call* and then press **OK** (Select).

➔ Use **☰/アプリ** to select *Volume* and then press **OK** (Select).

➔ Use **☰/アプリ** to adjust the volume and then press **OK** (OK).

- Each press of **☰/アプリ** changes the volume one step.

STEP UP	The ring tone volume gradually increases.
5 (Deka) (loud) ↓ 1 (soft)	The ring tone sounds at the set volume.
OFF	The ring tone does not sound.

Turning On the Answer Memo

When the standby screen is displayed, hold down **戻る** for at least one second.

戻る is displayed on the standby screen.

Turning Off the Answer Memo

When the standby screen is displayed, hold down **戻る** for at least one second. The answer memo is turned off and **戻る** disappears from the standby screen.

- The cell phone can record a maximum of ten messages, each up to 60 seconds long.
- Answer memo is a function that automatically answers calls and allows callers to record messages. Use the Answering Service (Voice Mail) when your phone is turned off or when you are in a location where a signal cannot be received.

Playing a Message

If a message is recorded, *AnswerMemo* appears on the standby screen.

➔ Use **☰/アプリ** to select *AnswerMemo* and then press **OK** (Check).



















➔ Use **☰/アプリ** to select *Play Memo* and then press **OK** (Select).

➔ Use **☰/アプリ** to select the message you want to play and then press **OK** (Play).

- To stop playing the message, press **OK** (Stop).

Deleting a Message

When the standby screen is displayed, press .

- ➔ Use  /  to select *Answer Memo* and then press  (Select).
- ➔ Use  /  to select *Play Memo* and then press  (Select).
- ➔ Use  /  to select the message you want to delete and then press  (Menu).
- ➔ Use  /  to select *Delete* and then press  (Select).
- ➔ Use  /  to select *Delete One* and then press  (Select).
- ➔ Use  /  to select *YES* and then press  (OK).

Character Input

Character Entry Modes

When a character entry screen is displayed, you can select a character entry mode if you press (ChrTyp).

Menu Items

漢あ : Kanji/hiragana mode

カナ : Double-byte katakana mode

か : Single-byte katakana mode

Aa : Double-byte alphanumeric mode

Aa : Single-byte alphanumeric mode

12 : Double-byte number mode

12 : Single-byte number mode

Use /// to select a character entry mode and then press (Select).

Entering Alphanumeric Characters

You can use the keys to to enter characters.

More than one character is assigned to each key.

The following table shows the key assignment for entering characters.

Key	Number of Times to Press the Key									
	1	2	3	4	5	6	7	8	9	
	.	@	-	_	/	:	~	1		
	a	b	c	A	B	C	2			
	d	e	f	D	E	F	3			
	g	h	i	G	H	I	4			
	j	k	l	J	K	L	5			
	m	n	o	M	N	O	6			
	p	q	r	s	P	Q	R	S	7	
	t	u	v	T	U	V	8			
	w	x	y	z	W	X	Y	Z	9	
	Inputs symbols								0	
	Inputs symbols (switches an unconfirmed character between uppercase and lowercase).									
	Adds a line break and displays characters in the opposite order.									

When you change your e-mail address, you cannot use the characters in for the account name (part of the address to the left of @).

Entering Two or More Characters Assigned to the Same Key

After you enter the first character, press **[先出]** and then enter the next character.

Deleting Characters

To delete one character at a time, move the cursor to the character you want to delete and then press **[戻る]**. To delete all characters to the right of the cursor, hold down **[戻る]** for at least one second. If there are no characters to the right of the cursor, holding down **[戻る]** will delete all the characters.

Starting a New Line

Press **[#]**.

- Certain functions such as C-mail do not support entering new lines.

Entering E-mail Addresses

E-mail Address Compatible Characters

- Before you enter an e-mail address, switch to the single-byte alphanumeric mode.
- When changing your e-mail address, you can enter up to 30 single-byte alphanumeric and symbol characters for the account name (part to the left of @). Note the following:
 - Uppercase characters cannot be used.
 - Period (.) or zero (0) cannot be used as the first character.

How to Enter E-mail Addresses

Example: Entering "taro.23@kddi.co.jp"

Enter "taro.23".













- t : Press **[8]** once.
- a : Press **[2]** once.
- r : Press **[7]** three times.
- o : Press **[6]** three times.
- . : Press **[1]** once.
- 2 : Press **[2]** once and then **[#]**.
- 3 : Press **[3]** once and then **[#]**.

➔ Enter "@".

- @ : Press **[1]** twice.















➔ Enter "kddi".

- k : Press **[5]** twice.
- d : Press **[3]** once and then **[先出]**.
- d : Press **[3]** once.
- i : Press **[4]** three times.

- ➔ Press  (Menu).
- ➔ Use  /  to select *Get* and then press  (Select).
- ➔ Use  /  to select *UsefulSentence* and then press  (Select).
- ➔ Use  /  to select *Internet* and then press  (Select).
- ➔ Use  /  to select *.co.jp* and then press  (OK).
".co.jp" is entered.

Entering Pictograms

When a character entry screen is displayed, press  (ChrTyp).

- ➔ Use  /  /  /  to select   and then press  (Select).
- ➔ Use  /  /  /  to select the pictogram you want to enter and then press  (OK).
 - You can enter pictograms consecutively if you press  (Continue) instead of  (OK).

Phone Book

Saving a Phone Book Entry





When the standby screen is displayed, hold down  for at least one second.

➔ Use  /  to select  [*Name*] and then press  (Edit).

➔ Enter a name and then press  (OK).
The  [*Reading*] for the name is entered automatically.

➔ Use  /  to select  [*Phone No.1*] and then press  (Edit).

➔ Enter a phone number and then press  (OK).
• If the phone number is for a fixed-line phone, enter the phone number starting with the area code.

➔ Use  /  to select a phone number type and then press  (OK).
• Follow the next step to enter an e-mail address. If you do not want to enter an e-mail address, press  (Comp).

➔ Use  /  to select  [*E-Mail Address1*] and then press  (Edit).

➔ Enter an e-mail address and then press  (OK).





➔ Use  /  to select an e-mail address type and then press  (OK).



➔ Press  (Comp).



- The phone book can store up to 1,000 entries.
- The cell phone automatically saves an entry to the lowest available memory number from 000 to 999.
- You can save three phone numbers and three e-mail addresses for each phone book entry.
- You can also assign a group No., and enter birthday, address, and other information.

Dialing from the Phone Book

When the standby screen is displayed, press .

➔ Use  /  /  /  to select the entry containing the phone number you want to dial and then press  (Detail).

➔ Use  /  to select the phone number and then press  (Select).

➔ Use  /  to select *Call* and then press  (Call).



Editing Phone Book Entries

When the standby screen is displayed, press .

➔ Select an entry and press  (Detail).



➔ Press  (Edit).

➔ Edit the contents and then press  (Comp).

➔ Use  /  to select *YES* and then press  (OK).

Saving a Phone Number from the Incoming or Outgoing History

Example: Saving a phone number from the incoming history to the phone book

When the standby screen is displayed, press  and use  /  to select the phone number you want to save.

➔ Press  (Menu).

➔ Use  /  to select *Add to Adr Bk* and then press  (Select).

➔ Use  /  to select *New* and then press  (Select).

➔ Use  /  to select a phone number type and then press  (OK).

- For details on saving a phone book entry, see page 24.

Pair Function

You can register a maximum of three pair partners you contact often to easily call or send mail.

Registering a Pair Partner

When the standby screen is displayed, press

① / ② / ③ .

- ➔ Use / to select *YES* and then press (OK).
- ➔ Use / / / to select a pair partner, press (Detail) and then (OK).
 - When registering a phone book entry with multiple phone numbers and e-mail addresses as pair partner, select the phone number and e-mail address to use with the Pair function.
 - When you delete a phone book entry registered in the pair partner, the phone book entry is also deleted from the Pair function.

Making a Call to a Pair Partner

When the standby screen is displayed, press

① / ② / ③ .

➔ Press (通話) .

Sending Mail to a Pair Partner

When the standby screen is displayed, press (通話) .

- ➔ Use / to select the person you want to send mail.
- ➔ Use / to select *E-Mail* or *C-Mail* and then press (Select).
 - To create an e-mail message, see "Creating and Sending E-mail Messages" on page 27. To create a C-mail message, see "Creating and Sending C-mail Messages" on page 30.

Using E-mail



























To use e-mail, you need to apply for an EZweb subscription. If you did not apply for an EZweb subscription at the time of purchase, contact an au shop or the au Customer Service Center. Also, before use, you need to configure initial settings.

You can send and receive e-mail with other cell phones that support e-mail, and with PCs. In addition to text messages of up to 5,000 double-byte (or 10,000 single-byte) characters, you can also send photos and movies by e-mail.

- The packet communication charge for sending and receiving e-mail applies to the amount of data sent and received.
- You can send an e-mail message to up to 30 different addresses at one time.
- You can send up to 1,000 e-mail messages per day (a message with multiple recipients is counted as more than one message).
- Sending and receiving e-mail messages that include attachment data may take a while.

Creating and Sending E-mail Messages

When the standby screen is displayed, press .

- ➔ Use  /  to select *Create New E-Mail* and then press  (**Select**).
- ➔ Use  /  to select *Destination* and then press  (**Edit**).
- ➔ Use  /  to select *Get Adr Bk (1)* and then press  (**Select**).
- ➔ Use  /  /  /  to select a phone book entry and then press  (**OK**).
- ➔ Use  /  to select an address and then press  (**OK**).
- ➔ Use  /  to select *Subject* and then press  (**Edit**).
- ➔ Enter a subject and then press  (**OK**).
 - You cannot enter single-byte katakana characters or a new line in a subject.
- ➔ Use  /  to select *Body* and then press  (**Edit**).
- ➔ Enter text and then press  (**OK**).
 - You cannot enter single-byte katakana characters.
- ➔ Press  (**Send**).

Reading Received E-mail Messages

When you receive an e-mail message, *New E-Mail* appears on the standby screen.

➔ Use / to select *New E-Mail* and then press (Check).

➔ Press (Select).

- : Indicates a read message.
- : Indicates an unread message.

➔ Use / to select the new message and then press (View).

Reading an E-mail Message from the E-mail Menu

When the standby screen is displayed, press to display the E-mail menu, use / to select *Inbox* and then press (Select).

For subsequent operations, see "Reading Received E-mail Messages" above.

Reading an E-mail Message with an Attached Photo or Movie

Example: Viewing an attached photo

Display the e-mail message that has an attached photo (above).

➔ Use / to select the file name and then press (Select).

➔ Use / to select the file name and then press (Receive).

➔ Press (Play).

- Selecting the file name or pressing (Receive) may be unnecessary for some files to be displayed, depending on the file size.

Replying to Received E-mail Messages

When the standby screen is displayed, press .

➔ Use / to select *Inbox* and then press (Select).

➔ Press (Select).

➔ Use / to select the message you want to reply to and then press (View).

➔ Press (Reply).

"Re:" is prefixed to the subject, and the text of the message is quoted.

➔ Refer to "Creating and Sending E-mail Messages" (page 27) for subsequent operations.



















Rejecting Spam

Setting mail filters to reject spam is recommended. The サポート設定 (Supportive Settings) helps you to set mail filters easily by answering questions that appear on the screen.

Setting Mail Filters

Example: Connecting to サポート設定 (Supportive Settings)

When the standby screen is displayed, press .

- ➔ Use  /  to select *E-Mail Setup* and then press  (Select).
- ➔ Use  /  to select *Mail Filter* and then press  (Select).
- ➔ Use  /  to select 次へ (Next) and then press  (Select).
- ➔ Use  /  to select the input box and then press  (Edit).
- ➔ Enter your security code and then press  (OK).
- ➔ Use  /  to select 送信 (Send) and then press  (Select).
- ➔ Use  /  to select サポート設定 (Supportive Settings) and then press  (Select).

■ カンタン設定 (Simple Settings)

サポート設定 (Supportive Settings)	Set the filter by answering questions This is recommended for users who want to configure settings while confirming conditions.
フィルターレベル (高) Filter Level (High)	Shut out all mail from PCs This is recommended for users who only want to send mail to and receive mail from cell phones.
フィルターレベル (中) Filter Level (Medium)	Block unsolicited advertisement, spoof e-mail and mail from specific addresses This is recommended for users bothered by certain senders or spam mail.
フィルターレベル (低) Filter Level (Low)	Block unsolicited advertisement and spoof e-mail This is recommended for users who wish to use the minimum filter setting.

- You can also prevent spam by changing your e-mail address. For details on changing your e-mail address, see page 14.

Using C-mail

C-mail is a service that uses phone numbers as addresses to exchange messages between au cell phones that support C-mail. A C-mail message can contain up to 50 double-byte (or 100 single-byte) characters.

- The C-mail send charge applies when sending C-mail.















C-mail Safety Block









C-mail safety block is a function that allows you to reject C-mails that include URLs (<http://△△△>, <https://△△△>) or phone numbers in the C-mail message text.

C-mail safety block is valid by default. Cancel the setting if you want to receive C-mails that include URLs and phone numbers in the message text.

Creating and Sending C-mail Messages









When the standby screen is displayed, hold down  for at least one second.

- ➔ Use  /  to select *Create New C-Mail* and then press  (Select).
- ➔ Use  /  to select  [*Destination*] and then press  (Edit).
- ➔ Use  /  to select *Get AddressBook* and then press  (Select).
- ➔ Use  /  /  /  to select a phone book entry and then press  (OK).





- ➔ Use  /  to select a phone number and then press  (OK).
- ➔ Use  /  to select  [*Body*] and then press  (Edit).
- ➔ Enter text and then press  (OK).
- ➔ Press  (Send).

Reading Received C-mail Messages

When you receive a C-mail message, *New C-Mail* appears on the standby screen.

- ➔ Use  /  to select *New C-Mail* and then press  (Check).
 - : Indicates a read message.
 - : Indicates an unread message.
- ➔ Use  /  to select the new message and then press  (View).

Reading a C-mail Message from the C-mail Menu

When the standby screen is displayed, hold down  for at least one second to display the C-mail menu, use  /  to select *Inbox* and then press  (Select).

For subsequent operations, see "Reading Received C-mail Messages" above.

Camera

Your cell phone has a CMOS camera with 1.97 effective megapixels for shooting photos and movies. You can use the self-timer and autofocus.

Shot images can be used for the standby screen, and attached to e-mail messages.

Photo Taking Tips

When taking photos, position the cell phone so that  is not displayed upside down or inclined. Frame the subject within the display and hold the cell phone steady with both hands to avoid shaking.

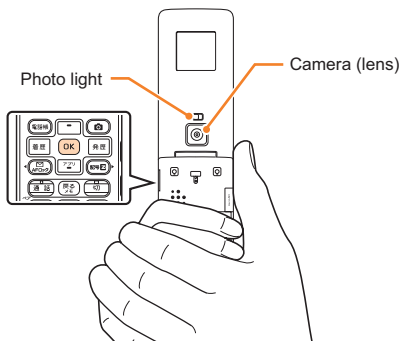

About Photo Modes

The following modes are available for taking photos.

Mode	Photo Size	Storage Location
Wallpaper	Wallpaper	The <i>Photo Folder</i> in the Data Folder of the cell phone
	Wallpaper (Wide)	
Camera	0.3M	The <i>Camera Folder</i> in the Data Folder of a microSD memory card*
	1M	
	2M	

* When a microSD memory card (commercially available) is not inserted, the files are saved to the Data Folder of the cell phone.

- Take care not to cover the lens with a strap or finger.

Taking a Photo

When the standby screen is displayed, press  .

The monitor screen appears.

➔ **Point the AF frame at the subject and then press  (Shoot).**

The camera focuses automatically and the shutter clicks. The preview screen is displayed.

Saving a Photo

Press  (Save) on the preview screen.

- If you do not want to save the photo, press  in the preview screen.

Viewing Photos

When the standby screen is displayed, press **OK**.

➔ Use **← / アプリ / 着歴 / 発歴** to select *Data Folder* and then press **OK** (Select).

➔ Use **← / アプリ** to select *Photo Folder* and then press **OK** (Select).

➔ Use **← / アプリ** to select a folder and then press **OK** (Select).

➔ Use **← / アプリ / 着歴 / 発歴** to select the photo you want to view and then press **OK** (Play).

EZweb is an information service that allows you to enjoy browsing the Internet on your cell phone. You can also download, Chaku-Uta®, news, and other contents from web pages.

To use EZweb, you need to apply for an EZweb subscription. If you did not apply for an EZweb subscription at the time of purchase, contact an au shop or the au Customer Service Center. Also, before use, you need to configure initial settings.

- The packet communication charge for EZweb connection applies to the amount of data sent and received, not to the length of time connected.
- In addition to communication charges, some sites charge for providing information.

Accessing Sites

■ Viewing the au one Top

You can access EZweb from the au one Top. A variety of useful and fun sites are available on EZweb. When the standby screen is displayed, press **[E]**, use **[←/→]** to select *au one Top* and then press **[OK]** (Select).



キーワード検索機能 (Search by Keyword) Provides a search function for searching for information by keyword.
カテゴリ(メニューリスト) (Category (Menu List)) Provides a list of various content provider sites.
トップニュース (Top News) Provides automatic updates of the latest news.
最新オススメ情報 (Latest News) Introduces up-to-date information concerning entertainment, daily life, etc.
天気・乗換・占い・テレビ・銀行 (Weather, Transportation, Horoscope, TV & Bank) Provides direct access to these au one services.
買う (Shopping & Auctions) Provides a list of shopping and auction sites available from your cell phone.
知る (Tips & Tools) Provides information on sports and stock prices, as well as useful tools such as maps and dictionaries.
楽しむ (Hobbies & Culture) Provides the latest information, such as games, music, books, hobbies and entertainment.
暮らす (Lifestyle) Provides travel, restaurant and other lifestyle-oriented information.

集まる (Community) Provides interesting and useful information that you can use for SNS or blogs.
メール (Mail) Provides an extra e-mail address that can be used on your PC.
マイページ (My Page) Provides useful information and tools tailored to your cell phone usage and a large data storage area.
au style Introduces information and sites that au recommends.
とくする情報 (Valuable Information) Presents gifts and push information to the EZweb subscriber for free.
auお客さまサポート (au Customer Support) Provides information about charges, various applications, au online manual and notices from au.
auワンちゃんの部屋 (au Doggy's Room) Introduces au Doggy.
カンタンアクセス・オープンサイト (Simple Access & Open Site) Provides easy access and introduces open sites.
災害用伝言板 (Disaster Message Board) Register and confirm safety information in time of disaster.
ENGLISH Introduces English sites.

Basic Operations

Use / to select the site you want to access and then press (OK).

Press to return to the previous screen. Hold down for at least one second to return to the au one Top.

The following describes the basic operations that are available while accessing sites.

Key Operation	Description
	Exits EZweb.
/	Moves the cursor up and down. When there is data available above or below the current screen, scrolls up and down the screen one line at a time.
/	When there is data available above or below the current screen, scrolls the screen page by page. : Scrolls one page up. : Scrolls one page down.
	Returns to the previous screen.

Bookmarking Frequently Accessed Pages

When the page you want to bookmark is displayed, press (Brow. Menu).

→ Use / to select *New bookmark* and then press (Select).

- Some pages cannot be bookmarked.

→ Press (Reg).

The displayed page is bookmarked, and its title and URL are added to the Bookmark.

- The Bookmark can contain up to 100 titles and URLs.

Viewing Bookmarked Pages

When the standby screen is displayed, press and then use / to select *EZweb*.

→ Use / to select *Bookmark* and then press (Select).

→ Use / to select the bookmark for the page you want to view and then press (Select).

The cell phone connects to the site.

Checking Charges

When the standby screen is displayed, press **OK**.

- ➔ Use **□ / アプリ / 着歴 / 発歴** to select *Set Functions* and then press **OK** (Select).
- ➔ Use **□ / アプリ** to select *Time/Toll/Subs* and then press **OK** (Select).
- ➔ Use **□ / アプリ** to select *Inquiry Toll* and then press **OK** (Connect).
- ➔ Press **OK** (OK).
 - Select the item you want to check and then follow the on-screen instructions.

Downloading Chaku-Uta®

When the standby screen is displayed, press **E** and then use **着歴 / 発歴** to select *EZweb*.

- ➔ Use **□ / アプリ** to select *au one Top* and then press **OK** (Select).
- ➔ Use **□ / アプリ** to select *カテゴリ (メニューリスト)* (Category (Menu List)) and then press **OK** (OK).
- ➔ Use **□ / アプリ** to select *着うた (Chaku-Uta®)* and then press **OK** (Select).

- ➔ Use **□ / アプリ** to select the site you want to access and then press **OK** (Select).

The download instructions appear.

- Fee-based information sites require entry of EZ password or Premium EZ password. Follow the on-screen instructions to enter either password. See page 15 for details.

- ➔ Follow the on-screen instructions.

Download is completed.

- Downloaded data is saved automatically to the Data Folder.

- ➔ Press **電話帳** (Play).

The downloaded Chaku-Uta® plays.

- This procedure is only an example for the purpose of explanation and may differ from actual procedures. Follow the instructions on the site from which you want to download the data.

Use the EZ News Flash to display flash news on the standby screen. You can check the news details and other information by selecting the ticker field. You can use the EZ News Flash by making a few simple settings following the EZweb initial setup.

Basic Operations

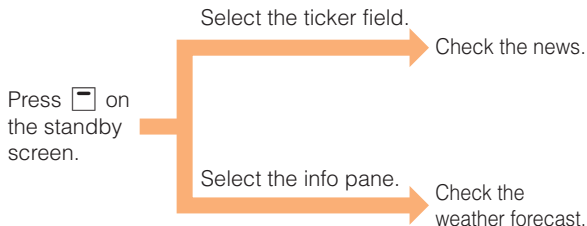

- The EZ News Flash information is automatically received at no charge. Note, however, that packet communication charges may be incurred for manual updates and connecting to EZweb sites. In this case, a confirmation screen for network connection is displayed.
- The EZ News Flash information is updated at regular time intervals.  appears while receiving information.

Setting EZ News Flash

The EZ News Flash is available free of charge. You have only to make a few simple settings. After following the procedure in “Initial Setup of E-mail and EZweb” on page 11, configure EZ News Flash settings. If you did not configure the EZ News Flash settings at the time of the initial setup, follow the steps below.

When the standby screen is displayed, press [] and select the ticker field and then press [OK] (OK).





➔ Follow the on-screen instructions.

The setup procedure is completed.

- When the standby screen returns, a message asking you to wait for a while until the next update takes place appears in the ticker field.

■ Canceling EZ News Flash

When the standby screen is displayed, press  and select the ticker field and then press  (OK).

➔ Press  (メニュー[Menu]), use  /  to select サービス設定解除 (Service Cancellation) and then press  (選択[Select]).

➔ Follow the on-screen instructions.

■ Changing the Reception Settings for EZ News Flash Information

You can change the ring tone, vibrator and LED settings under M215 *NewsFlash Rcv* for reception of EZ News Flash information.

If you do not want the ring tone to sound when receiving EZ News Flash information, set the volume to *OFF*.

Using GPS (Global Positioning System), EZ Navi provides useful positional information services.

When the standby screen is displayed, press  and then use  /  to select the EZnavi.

- The packet communication charges for using EZ Navi services apply to the amount of data sent and received. Some services may require a separate information fee.
- Before using EZ Navi, you must configure initial settings of EZweb (page 11).

Passenger Seat Navi for People in the Passenger Seat to Check the Route

Passenger Seat Navi guides the passengers to the destination with the best route using voice and map.

Drivers are not allowed to use Passenger Seat Navi.

Security Navi to Check Where Your Kids Are

The Security Navi application is made up of the following three functions:

いつでも位置確認 (Auto Position Search [monthly charge]),
エリア通知 (Area Message [no monthly charge]),
位置確認メール (Position Search Mail [no monthly charge])

Using these functions, you can check the position of an au cell phone that supports Security Navi; and automatically send a notification to the specified au cell phones when you enter (or are in) or leave (or are no longer in) the set area within a predetermined period of time.

EZ Navi Walk for When You Go Out

Displays various useful menu items for when you are out. There are two menu modes: the Full Mode menu for those who want to use all the convenient functions including the latest features, and the Simple Mode menu with limited functions allowing you to use the service with simple operation.

The following table describes the Full Mode menu.

トータルナビ／地図 (Total Navigation/Map)	Find the most preferable combination of transportation (trains, airplanes, buses and taxis), and check out maps of your current location and places you like to go.
乗換／時刻表 (Connection/Timetable)	Search for train connections, timetables and other public transportation information.
お店／施設／イベント (Shop/Facility/Event)	Search for local stores, facilities or events.
ドライブ／渋滞情報 (Road/Traffic Information)	Check out road traffic information in real time.
オススメ便利メニュー (Useful Menu)	View information on services that are available on PCs, and use advanced functions of EZ Navi Walk that you can enjoy.
設定／会員登録／インフォ (Setting/Membership Registration/Information)	Configure various settings, sign up as a member or check out various useful information.

- Some of the menu options require a monthly charge.

View Your Current Location



★ represents your initial location. As you start moving, changes of your location are tracked by continuous positioning and indicated in real time by .

The *現在地の地図* (View Your Current Location) option displays the current map in real time.

3D Navi

Shows a 3D view at guidance points and around the destination area.

Evacuate Navi to Guide You Home or to Nearby Evacuation Areas during Disasters

Nearby public evacuation areas or the direction to your home can be determined using the map data pre-installed on the K003 (避難所マップ[Evacuate Area Map]). Other useful contents can be downloaded from the 災害時ナビ(Evacuate Navi) section of the EZweb site.

- Some contents require a monthly charge.
- Use the information on the screen as a reference and always follow the instructions of police, fire and other municipal authorities.

In Case of Loss of Your K003

The Remote Ctrl Lock allows you to remotely activate the Auto Lock, and Address Book Lock, preventing others from using your cell phone.

Setting Conditions for Activating the Remote Ctrl Lock

You can activate the Remote Ctrl Lock by calling your K003 a set number of times from a registered phone number within a specified period of time.

When the standby screen is displayed, press **OK**.

- ➔ Use **□/□/□/□/□** to select *Set Functions* and then press **OK** (Select).
- ➔ Use **□/□** to select *Priv/Restrict* and then press **OK** (Select).
- ➔ Use **□/□** to select *Security Lock* and then press **OK** (Select).
- ➔ Use **□/□** to select *Remote Lock* and then press **OK** (Select).
- ➔ Enter *Lock No.*, and then press **OK** (OK).
- ➔ Use **□/□** to select *ON/OFF Setup* and then press **OK** (Select).
- ➔ Use **□/□** to select *ON* and then press **OK** (OK).

- ➔ Use **□/□** to select *Caller No.List* and then press **OK** (Select).
- ➔ Use **□/□** to select *00* and then press **OK** (Edit).
- ➔ Use **□/□** to select *Input Phone No.*, press **OK** (Select), enter a phone number, and then press **OK** (OK).
- ➔ Press **電話帳** (Back).
- ➔ Use **□/□** to select *Set Time* and then press **OK** (Select).
- ➔ Enter a time and then press **OK** (OK).
 - This sets the time limit for receiving the set number of calls after the first call is received.
 - You can set a time from one to ten minutes.
- ➔ Use **□/□** to select *No. of Calls*, and then press **OK** (Select).
- ➔ Enter a number of calls, and then press **OK** (OK).
 - This sets the number of calls to receive to activate the Remote Ctrl Lock.
 - You can set a number of calls from five to ten.
- ➔ Press **電話帳** (Back).

Remotely Activating the Remote Ctrl Lock on Your K003

Call the K003 from the registered phone number repeatedly within the set time limit.

- When the specified number of calls are received, the Remote Ctrl Lock is activated and a message plays telling you that the cell phone is locked.

Activating the Remote Ctrl Lock by the Security Lock Service

Even if the Remote Ctrl Lock is not set in advance, the Remote Ctrl Lock can be activated by calling au Customer Service Center or completing the application process on au Customer Support from a PC.

The Security Lock Service is available free of charge.

Calling au Customer Service Center for Activating/Canceling the Remote Ctrl Lock

From an au cell phone: 113 without a prefix (toll free)

From any other cell phone or fixed-line phone:

 0077-7-113 (toll free)

Open 24 hours

Follow the voice guidance to complete the application process.





Activating/Canceling the Remote Ctrl Lock from a PC

Login to au Customer Support (<https://cs.kddi.com/>) and complete the application process by following the on-screen instructions.

- The Remote Ctrl Lock cannot be activated when the K003 is turned off or out of the service area, or Emission OFF is set.
- You must fill out an application to use au Customer Support (the application can be filled out even after your cell phone is lost).

Troubleshooting

Symptom	Possible Cause	Remedy	Page
Cannot turn on power.	● Is the battery pack charged?	Charge the battery pack.	8
	● Did you slide the power switch toward 入?	Slide the power switch toward 入.	10
Cannot make calls.	● Is power turned on?	Slide the power switch toward 入.	10
	● Is ^{Out of} Range (out of range indicator) displayed?	Move to a location where ^{Out of} Range (out of range indicator) is no longer displayed, and try again.	12
	● Is your hand or a metal object covering the area around the built-in antenna?	Make sure your hand or any other metal object is not covering the area around the built-in antenna.	7
	● Did you enter the phone number starting with the area code?	When making a call to a phone other than a cell phone, you need to enter the area code even if you are inside the same area.	16
Cannot receive calls.	● Is ^{Out of} Range (out of range indicator) displayed?	Move to a location where ^{Out of} Range (out of range indicator) is no longer displayed.	12
	● Is power turned on?	Slide the power switch toward 入.	10
No response when a key is pressed.	● Is power turned on?	Slide the power switch toward 入.	10
A warning tone sounds and power turns off.	● Is there enough power left in the battery pack?	Charge the battery pack.	8
Calls are answered automatically.	● Is Answer memo turned on?	Hold down [戻る] for at least one second to turn off Answer memo.	19

Symptom	Possible Cause	Remedy	Page
Cannot hear the other party.	● Is the earpiece volume too low?	Press  during a call to increase the earpiece volume.	18
When making a call, a beeping sound is heard from the earpiece and a connection cannot be established.	● Is  (out of range indicator) displayed? Or are you in a location where the signal is too weak?	Move to a location where  (out of range indicator) is no longer displayed.	12
	● Is the wireless line busy or is the phone you are calling on another line?	End the call and try again later.	16
The incoming LED flashes but the ring tone does not play.	● Is manner mode turned on?	Hold down  for at least one second to turn off manner mode.	18
	● Is  (ring tone off indicator) displayed?	Increase the volume of the incoming call ring tone.	19
Cannot charge the battery pack.	● Is the battery pack installed properly?	Install the battery pack properly.	8
	● Are the plug and connector of the AC adapter inserted properly?	Insert the plug and connector firmly.	
When the camera is activated, no subject is displayed.	● Is a finger or other object covering the camera (lens)?	Check the position of the camera (lens) and remove the obstacle.	31

- For more detailed information, visit the following au troubleshooting sites:
 - From an au cell phone:  ⇒ *au one Top* ⇒ *auお客様サポート* (au Customer Support) ⇒ *オンラインマニュアル* (Online Manual) ⇒ *故障診断Q&A* (Troubleshooting FAQ)
 - From a PC: <http://www.kddi.com/customer/service/au/trouble/kosho/index.html>

Index

A

Accessories	6
Answer memo	19
Playback	19
Turning off	19
Turning on	19

B

Battery level	12
Battery pack	6,8
Battery pack cover	7

C

Camera	31
Photo taking tips	31
Taking a photo	31
Cell phone etiquette	2
Character input	21
Character entry modes	21
Deleting characters	22
Entering characters from the same key	22
Starting a new line	22
Charging the battery pack	8
Checking charges	36
C-mail	30
C-mail safety block	30
Creating and sending	30

Reading Received mail	30
Contents	4

D

Disaster Message Board Service	3
Display	7,12
Domain	14
Downloading Chaku-Uta®	36

E

Earpiece volume	18
E-mail	27
Creating and sending	27
Initial settings	11
Reading Received mail	28
Replying	28
Viewing attached images	28
E-mail address	11
Available characters	21
Changing	14
Entering	22
Entering pictograms	23
Evacuate Navi	41
EZ Navi	39
EZ Navi Walk	40
EZ News Flash	37
Canceling	38
Changing the Reception Settings	38
Info pane	37
Setting	37

Ticker field	37
EZ password	15
EZweb	33
Accessing sites	34
au one Top	34
Basic operations	35
Initial settings	11

I

Incoming history	17
Indicators	12
Initial settings	11
E-mail · EZweb	11
International Call	16
Internet	33
Sites	34,35

K

Key assignments	9
-----------------------	---

L

Language	10
Learning the basics	9
Lock No.	15

M

Mail	27
C-mail	30
E-mail	27

Mail filters	29
Simple settings	29
Main menu	13
Manner mode	18
Message Menu	10

N

Names of parts	7
----------------------	---

O

One-ring calls	17
Outgoing history	17

P

Pair Function	26
Making a call to a pair partner	26
Registering a pair partner	26
Sending mail to a pair partner	26
Passenger Seat Navi	39
Passwords	15
Phone (call)	16
184/186	16
Answering	17
International Call	16
Making	16
Returning	17
Phone book	24
Dialing	24
Editing	24
Saving	24

Saving a phone number from the incoming or outgoing history	25
Phone number	11
Photos	31
Photo modes	31
Taking	31
Viewing	32
Playback	
Answer memo	19
Premium EZ password	15

R

Remote Ctrl Lock	42
Ring tones	
Changing the type	18
Changing the volume	19

S

Security code	15
Security Lock Service	43
Security Navi	39
Signal strength	12
Sites	34
Bookmarking	35
Viewing from bookmarks	35
Spam	29
Sub-display	13

T

Troubleshooting	44
Turning on/off power	10

V

Viewing	
Photos	32

For inquiries, call: au Customer Service Center

For general information and charges (toll free)

From fixed-line phones:
 0077-7-111

From au cell phones:
157 area code not required

PRESSING ZERO WILL CONNECT YOU TO AN OPERATOR
AFTER CALLING 157 ON YOUR au CELL PHONE

For loss, theft or damage and operation information
(toll free)

From fixed-line phones:
 0077-7-113

From au cell phones:
113 area code not required

From EZweb:

Access Method  au one Top ▶ auお客様サポート (au Customer Support)
▶ お問い合わせ (Inquiries)
▶ Menus are subject to change without prior notice.

なるほど! au
みんなでつくる、auQ&Aサイト

Access Method  au one Top ▶ auお客様サポート (au Customer Support)
▶ みんなでQ&A「なるほど! au」 (au User's Forum)

Read this code for an easy
access to なるほど! au
(au User's Forum). ▶

- The packet communication charge applies.



モバイル・リサイクル・ネットワーク
00661-046-0077-111100076

Cell phone and PHS operators collect and recycle unused telephones, batteries and battery chargers at stores bearing the ♻️ logo regardless of brand and manufacturer to protect the environment and reuse valuable resources.

Read this code for
an easy access to
au Online Manual.



August 2009 1st Edition

Sales: KDDI CORPORATION・
OKINAWA CELLULAR TELEPHONE COMPANY
Manufactured by: KYOCERA Corporation